

8 / 16 CHANNEL SWITCHER

SE-3000



Instruction Manual

www.datavideo-tek.com

Table of contents

Warnings and Precautions	6
Warranty	7
Standard Warranty	7
Two Year Warranty	7
Disposal	7
For EU Customers only - WEEE Marking.....	7
Packing List	7
Introduction	8
Features.....	9
Main Unit	10
Front Panel	10
Rear Panel.....	10
Control Panel	10
Keyboard	10
Keyboard Rear.....	10
Input & Output Connections – Main Unit	11
Control Panel to Main Unit Ethernet Connection	13
Power	13
Main Unit.....	13
Control Panel	13
Video Connections	14
SDI Video Inputs	14
Setting the Resolution of the SE-3000	14
<i>DVI Input – Input 8</i>	15
<i>Input Channels 9~16</i>	15
Video Outputs	16
<i>Auxiliary HD-SDI Outputs 1~4</i>	16
<i>How to assign Auxiliary Output sources</i>	16
Monitor Connections	17
Multi Image Preview	17
Multi Image Preview – Initial Set Up.....	17
Modifying the chosen MultiViewer Layout	18
<i>Changing Main Screens 1~4</i>	18
<i>Modifying the Multi Image Preview Labels</i>	19
Source Select Button Group	20
Aux Bus – Top Button Row	20
Program – Middle Button Row	20
Preset – Bottom Button Row	20
Transitions Group	20
AUTO TRANS Button.....	20
CUT Button	20
MIX Button	20
WIPE Button	21
DVE Button	21

Previewing a selected transition.....	21
REV and NORM / REV buttons.....	21
WIPE Selection Menu.....	22
Wipe	22
<i>Soft Value</i>	22
<i>Width Value</i>	23
<i>Level Value</i>	23
<i>Soft Balance</i>	23
Wipe Border.....	23
<i>Colour Palette</i>	23
<i>Hue, Sat and Luma values</i>	23
<i>Source Control</i>	23
Wipe Shade	24
<i>Colour Palette</i>	24
<i>Hue, Sat and Luma values</i>	24
<i>Shade Soft</i>	24
<i>Shade Position</i>	24
Wipe Position.....	24
DVE Transitions Menu	25
Transition Selection.....	25
Home Menu – Length of Transition.....	25
ME Trans	25
DSK Trans	25
FTB Trans.....	25
Freeze Menu	26
Freeze On / Off	26
Mode.....	26
Stills Menu.....	27
Grabbing & Saving a Still to memory.....	27
Loading an existing Still from memory.....	28
<i>Deleting a saved Still from memory</i>	28
Bus Matte Menu	29
Colour Palette	29
Hue, Sat and Luma values.....	29
Storing and Recalling USER Set Ups	30
How to quickly save a User Set Up	30
<i>Labelling an existing User memory slot</i>	30
Loading a previously saved User Set Up.....	31
<i>Deleting a User Set Up</i>	31
Flex™ Overview	31
Flex™ screen order.....	32
Saving the Flex™ set up	32
Flex™ Set Up Menus.....	32
Flex™ Source Select	33
Flex DVE1 (PiP1) and DVE2 (PiP2).....	33
DVE Position.....	33
<i>The Enable option</i>	33

<i>The Rotation value</i>	33
<i>The X and Y values</i>	33
<i>The Z value</i>	34
DVE Size	34
<i>The Z value of DVE Size</i>	34
<i>The Soft value of DVE Size</i>	34
DVE Border.....	34
<i>Hue, Sat and Luma values</i>	34
<i>Size</i>	34
<i>Soft</i>	34
DVE Crop.....	35
<i>Left, Right, Top and Bottom edge</i>	35
<i>The Size value</i>	35
Flex™ Keyer Menu	35
Flex™ Key and Fill Example CG-350 Set Up	36
Chroma Key Overview	37
A good foreground image helps produce a good key	37
<i>Three Chip Camera</i>	37
<i>Do not mix SD and HD standards when keying</i>	37
<i>White Balance the Camera</i>	37
<i>Lighting</i>	38
Control Panel Button Groups used.....	38
Chroma Key Quick Set Up	39
Chroma Matte	40
Chroma Key Ctrl	40
<i>Key Acceptance</i>	40
<i>Key Lift</i>	40
<i>Key Gain</i>	40
Color Spill	41
<i>Chroma Acceptance</i>	41
<i>Chroma Suppress</i>	41
Saving the Chroma Key set up.....	41
Luma Key Overview	41
Luma Key Quick Set Up	42
Luma Key – Lift	43
Luma Key – Gain	43
<i>Luma Key – Opacity</i>	43
<i>Luma Key – Invert</i>	43
<i>LIN Button</i>	43
<i>SELF Button</i>	43
<i>TOP Button</i>	43
Saving the Luma Key set up	43
Mask Menu	44
Keyer Matte	45
Colour Palette	45
<i>The Hue adjustment</i>	45

<i>The Sat or Saturation value</i>	45
<i>The Luma value</i>	45
Using Key 1 and Key 2	46
Transition Controls	46
<i>BGND - Background</i>	46
<i>KEY1 / KEY2</i>	46
<i>Priority Button</i>	47
<i>Previewing a selected transition</i>	47
<i>REV and NORM / REV buttons</i>	47
DSK1 and DSK2 Quick Set Up	48
Saving the DSK1 DSK2 set up	49
SE-3000 Keying layers	49
<i>DSK Transitions</i>	49
Looping an External reference through the SE-3000	50
Tally Output	51
Tally connection to two ITC-100 units	52
Features awaiting firmware development	53
Clip Menu.....	53
Audio Menu.....	53
GPI connection	53
RS-232.....	53
RS-422 IN.....	54
RS-422 OUT	54
Updating the SE-3000 firmware	55
Checking Firmware Revisions	56
Drawing Control Panel & Main Unit	56
Specifications	57
Service and Support	58

Disclaimer of Product and Services

The information offered in this instruction manual is intended as a guide only. At all times, Datavideo Technologies will try to give correct, complete and suitable information. However, Datavideo Technologies cannot exclude that some information in this manual, from time to time, may not be correct or may be incomplete. This manual may contain typing errors, omissions or incorrect information. Datavideo Technologies always recommend that you double check the information in this document for accuracy before making any purchase decision or using the product. Datavideo Technologies is not responsible for any omissions or errors, or for any subsequent loss or damage caused by using the information contained within this manual. Further advice on the content of this manual or on the product can be obtained by contacting your local Datavideo Office or dealer.



Warnings and Precautions

1. Read all of these warnings and save them for later reference.
2. Follow all warnings and instructions marked on this unit.
3. Unplug this unit from the wall outlet before cleaning. Do not use liquid or aerosol cleaners. Use a damp cloth for cleaning.
4. Do not use this unit in or near water.
5. Do not place this unit on an unstable cart, stand, or table. The unit may fall, causing serious damage.
6. Slots and openings on the cabinet top, back, and bottom are provided for ventilation. To ensure safe and reliable operation of this unit, and to protect it from overheating, do not block or cover these openings. Do not place this unit on a bed, sofa, rug, or similar surface, as the ventilation openings on the bottom of the cabinet will be blocked. This unit should never be placed near or over a heat register or radiator. This unit should not be placed in a built-in installation unless proper ventilation is provided.
7. This product should only be operated from the type of power source indicated on the marking label of the AC adapter. If you are not sure of the type of power available, consult your Datavideo dealer or your local power company.
8. Do not allow anything to rest on the power cord. Do not locate this unit where the power cord will be walked on, rolled over, or otherwise stressed.
9. If an extension cord must be used with this unit, make sure that the total of the ampere ratings on the products plugged into the extension cord do not exceed the extension cord rating.
10. Make sure that the total amperes of all the units that are plugged into a single wall outlet do not exceed 15 amperes.
11. Never push objects of any kind into this unit through the cabinet ventilation slots, as they may touch dangerous voltage points or short out parts that could result in risk of fire or electric shock. Never spill liquid of any kind onto or into this unit.
12. Except as specifically explained elsewhere in this manual, do not attempt to service this product yourself. Opening or removing covers that are marked "Do Not Remove" may expose you to dangerous voltage points or other risks, and will void your warranty. Refer all service issues to qualified service personnel.
13. Unplug this product from the wall outlet and refer to qualified service personnel under the following conditions:
 - a. When the power cord is damaged or frayed;
 - b. When liquid has spilled into the unit;
 - c. When the product has been exposed to rain or water;
 - d. When the product does not operate normally under normal operating conditions. Adjust only those controls that are covered by the operating instructions in this manual; improper adjustment of other controls may result in damage to the unit and may often require extensive work by a qualified technician to restore the unit to normal operation;
 - e. When the product has been dropped or the cabinet has been damaged;
 - f. When the product exhibits a distinct change in performance, indicating a need for service.

Warranty

Standard Warranty

- Datavideo equipment is guaranteed against any manufacturing defects for one year from the date of purchase.
- The original purchase invoice or other documentary evidence should be supplied at the time of any request for repair under warranty.
- Damage caused by accident, misuse, unauthorized repairs, sand, grit or water is not covered by this warranty.
- All mail or transportation costs including insurance are at the expense of the owner.
- All other claims of any nature are not covered.
- Cables & batteries are not covered under warranty.
- Warranty only valid within the country or region of purchase.
- Your statutory rights are not affected.

Two Year Warranty

- All Datavideo products purchased after 01-Oct.-2008 qualify for a free one year extension to the standard Warranty, providing the product is registered with Datavideo within 30 days of purchase. For information on how to register please visit www.datavideo-tek.com or contact your local Datavideo office or authorized Distributors
- Certain parts with limited lifetime expectancy such as LCD Panels, DVD Drives, Hard Drives are only covered for the first 10,000 hours, or 1 year (whichever comes first).

Any second year warranty claims must be made to your local Datavideo office or one of its authorized Distributors before the extended warranty expires.

Disposal



For EU Customers only - WEEE Marking.

This symbol on the product indicates that it will not be treated as household waste. It must be handed over to the applicable take-back scheme for the recycling of Waste Electrical and Electronic Equipment. For more detailed information about the recycling of this product, please contact your local Datavideo office.

Packing List

The following items should be included in the box. If any items are missing please contact your supplier.

Item No.	Description	Quantity
1	SE-3000 Main Unit	1
2	SE-3000 Control Panel / Keyboard	1
3	AC Power Cord	2
4	Ethernet Cable 8P-8P 3m	1
5	4pin XLR Switch Mode Power Supply DC 12V 10A	1
6	4pin XLR Switch Mode Power Supply DC 12V 5A	1
7	USB cable	1
8	SE-3000 Instruction Manual	1

Introduction

The Datavideo SE-3000 is a professional, eight or sixteen channel High Definition SDI Video Switcher. The SE-3000's modular design allows the Main unit (2U high) to be mounted in a standard 19" rack. The Control unit can then be placed on a nearby flat work surface or built into a gallery or OB van desk. The Control Panel and Main unit communicate via a standard (straight through) Ethernet patch cable.

The switcher can be supplied with eight inputs and then be upgraded to sixteen channels at a later date. Alternatively the switcher can be purchased with all sixteen input channels already present. The SE-3000 Main unit can accept HD-SDI inputs and one DVI-D source input (channels 1~8). If you have purchased the sixteen channel version then inputs 9~16 also have the option to upscale four SD-SDI inputs to your chosen HD standard.

The SE-3000's built in TBCs can synchronise the input channels internally without the need for external genlock; although you can choose to loop an external reference through the SE-3000 if you wish to minimise the delay through the switcher. Each input channel is also provided with its own Colour Processor or Proc Amp.

The SE-3000 Multi Image Preview, via DVI-D or HD-SDI (BNC), can be fed to one or two large format LCD monitor screens, this helps keep the number of required monitors to a minimum. The SE-3000 can also provide four user delegated Auxiliary HD-SDI outputs, as well as providing HD Preview and Program outputs via HD-SDI (BNC) and Component (Y, Pb, Pr).

Normal mixer features such as Picture in Picture (PiP) as well as Cut, Wipe and Mix (dissolve) transitions are available. On top of these the SE-3000 can perform advanced Digital Video Effects (DVE) such as 3D page turn transitions and even produce a multi image FLEX™ output with key and fill layers.

The user defined FLEX™ output allows a choice of background image/video plus two optional PiPs which can be sized, rotated, positioned and cropped. Either PiP window can also have user defined coloured borders too.

The SE-3000 can be configured to allow paired video channels of foreground and background to provide Chroma or Luma keyed video outputs thus giving the option to create productions with a virtual studio feel.

Up to 100 still images can be captured from live video and stored in non-volatile memory for later inclusion in a project. User set ups can be defined and saved using the Control Panel Keyboard and Joystick or its 7" LCD touch screen menu panel.

Up to 1000 set ups (M/Es) can be stored in to the onboard user memory slots and recalled instantly at the press of a button using the user/shot box area of the control panel.

The SE-3000 can provide simple tally communication which can be easily incorporated into the Datavideo ITC-100 based talk back system or a bespoke tally light set up. Redundant connections for GPI, RS-232 and RS-422 are also provided so they can be incorporated into later firmware versions.

All in all the SE-3000 provides the right tools to light your creative imagination and meet your HD workflow needs. Push your live HD production envelope further and at lower cost than ever before.

That's Datavideo; sharing the value!

Features

- Up to 16 HD SDI Inputs (8 or 16 Inputs)
- Built-in SD-to-HD up converters for up to 4 sources simultaneously (inputs 9~16)
- Built-in frame syncs for each input
- Dedicated DVI Input (treated as input 8 via a menu option)
- Multi-image preview or Preview or Program output via DVI-D
- 1 M/E Switcher
- 4 Keyers (2 in Mix and Effect, 2 as DSK/ Down Stream Key)
- 2 Chroma Keyers in Mix and Effect
- 30+ Wipe Patterns, with variable border width, source/colour, softness
- Built-in DVE transition engine, with 80+ transitions including page turns
- FLEX™ - Dual Channel P-in-P Processor with Background & Keyer
- Program (PGM), Preview (PVW), Program +DSK, Preview +DSK outputs available
- HD Component and down converted SD Component output as well as HD-SDI output
- 4 user delegated auxiliary HD-SDI outputs
- Store up to 100 still images
- Up to 1000 set ups (M/Es) can be stored in to the onboard user memory slots
- Ergonomic, intuitive control panel for quick and easy operation
- Large 7" touch-screen LCD panel on control unit for easy menu navigation and setting changes
- PC Ethernet based control interface software available
- Planned update(s) for RS-232, RS-422 and GPI controls
- Planned update(s) for Audio and Clip menus
- Separate, 2U high, 19" rack mountable Main unit
- Proc Amp controls for black level, white stretch, white clip, Chroma gain for each input
- Selectable mixer HD Standards 1080i (59.94, 60, 50) or 720p (59.94, 60, 50)

Main Unit Front Panel



The front panel of the SE-3000 Main Unit has a ventilation plate; to prevent overheating please ensure that adequate airflow is provided. The Main Unit also comes with 19" rack mounts already fitted.

Rear Panel



Control Panel Keyboard

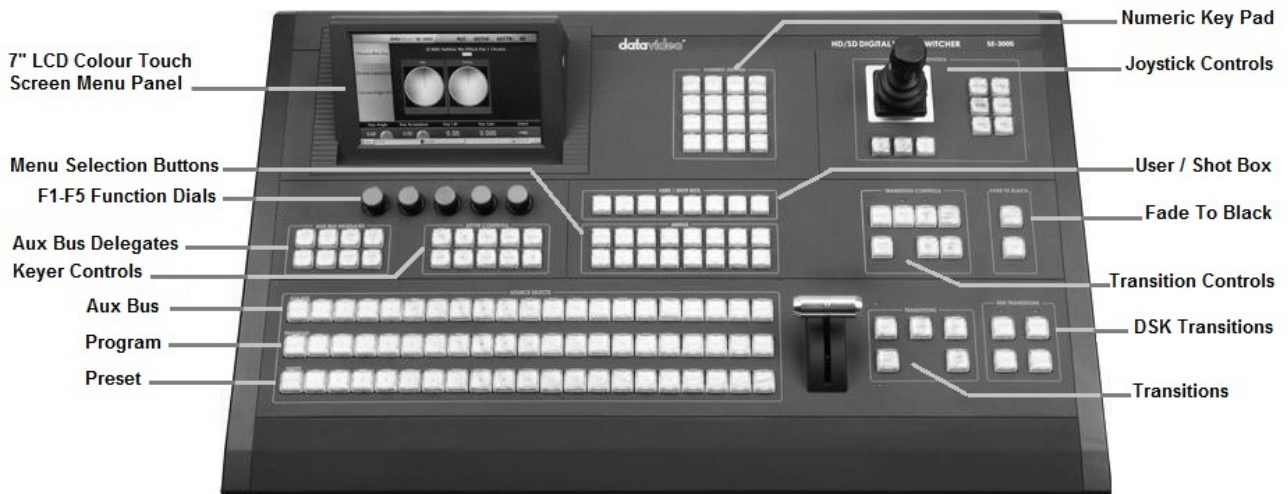

Keyboard Rear



Input & Output Connections – Main Unit



Starting from the bottom left corner.

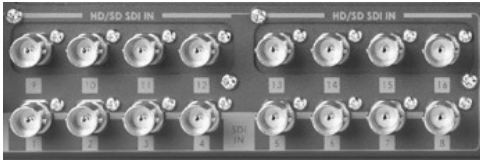

SDI / HD-SDI Inputs 1~8 & 9 ~16

The lower row of HD-SDI inputs are labelled 1~8. The upper row of SDI HD/SD inputs are labelled 9~16. If your unit has 8 inputs only then the upper row of BNC connectors will not be present.

Units with only 8 inputs can be upgraded to 16 inputs, please speak with your local Datavideo supplier for availability and price.



AUX Outputs 1~4

4 user delegated HD-SDI Auxiliary outputs – see page 16.

PGM & PVW Outputs

HD-SDI Program (PGM) and Preview (PVW) outputs.

MULTI-1 & MULTI-2 Outputs

HD-SDI Multi Image Preview of input sources with PGM, PVW, Still Store 1 and 2 – see page 17.



REF IN & REF LOOP

Use these connections to loop external house sync through the SE-3000 Mixer. See page 50.

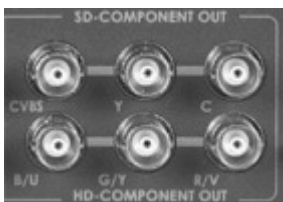

SD COMPONENT OUTPUT

Downscaled SD Component (YPbPr / RGB) PGM output.

HD COMPONENT OUTPUT

HD Component (YPbPr / RGB) PGM output.



DVI-D Input

This input can accept signals from computer or laptop. A DVI-D to HDMI cable is required if connecting a HDMI source here.

Any input needs to match the resolution of the mixer.



DVI-D Output

Can be set up to output Multi Image Preview, PGM or PVW

Any Monitor connected needs to match the mixer resolution



Ethernet Ports

Used to connect the Main Unit to the Control Panel / Keyboard. An additional Ethernet port is provided so that the unit can be controlled remotely via PC software - see page 12.

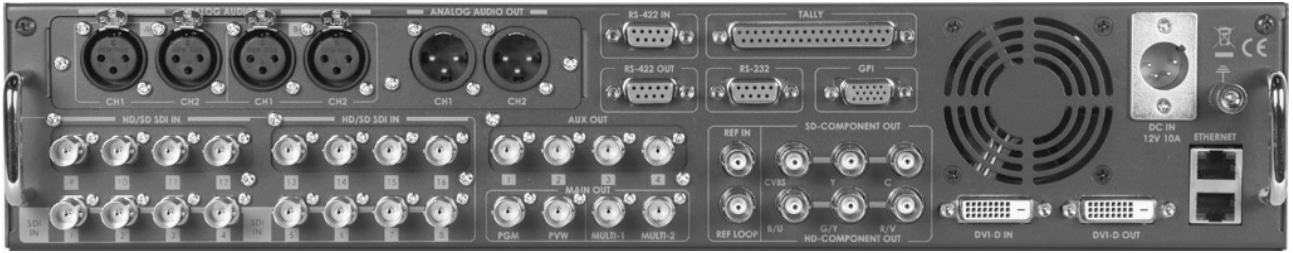

Starting from the Top left corner



XLR Balanced Audio Inputs



XLR Balanced Audio Outputs

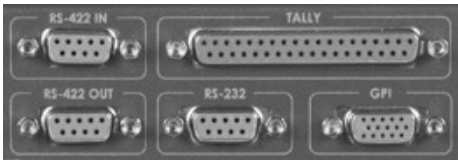

TALLY

37 Pin D-Sub connector. See page 51 for more information.

RS-422 IN & RS-422 OUT

9 Pin D-Sub connector. See page 54 for more information.

RS-232

9 Pin D-Sub connector. See page 53 for more information.

GPI

15 Pin D-Sub connector. See page 53 for more information.

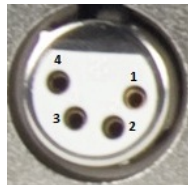
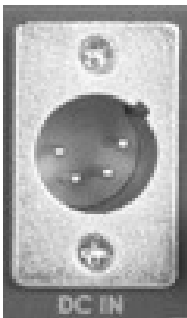

DC Input 12V 10A

- Pin 1 = GND (-)
- Pin 2 = NC
- Pin 3 = NC
- Pin 4 = VCC (+)



Case Earth Connector

Control Panel to Main Unit Ethernet Connection

The Control Panel / Keyboard communicates with the SE-3000 Main unit using the supplied 3m Ethernet (straight through) patch cable. There is one Ethernet port on the rear of the Control Panel / Keyboard and two Ethernet ports on the rear of the Main unit. Use any of these Ethernet ports for connecting the Control Panel to the Main unit.

The Main Unit can also

communicate over a simple Static IP PC network using a cross over Ethernet cable direct to a PC as shown above. In order to use this feature additional Windows based software is required. Please register your unit using the link below in order to receive this free application and the PC set up instructions.

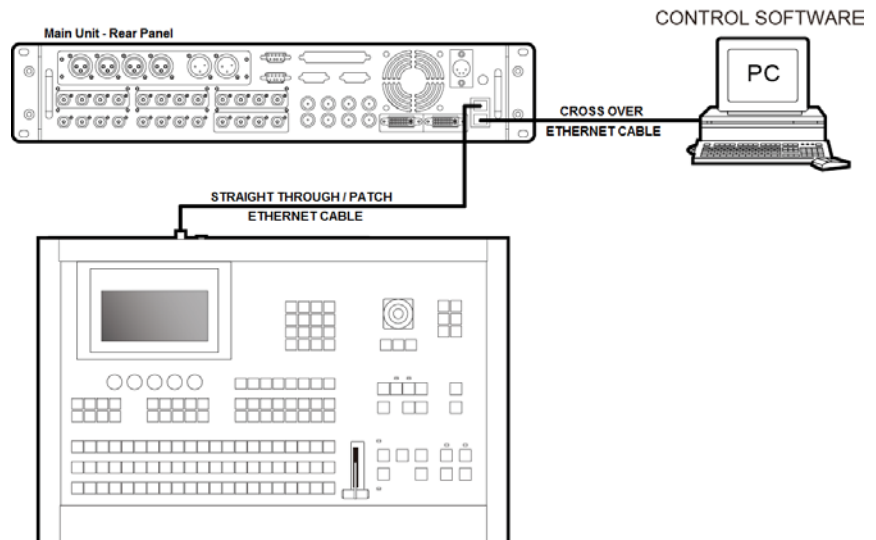

<http://www.datavideo.info/en/productReg.php>

Please note; using the Ethernet connection across an existing DHCP network may delay communication with the mixer. The default IP address for the Control Panel is 192.168.1.115 and the Main unit is 192.168.1.114. Both units can communicate with each other across an existing DHCP network but the IP addresses mentioned above need to be allowed on the network as static IP addresses. You may need the help of an I.T. specialist when setting up the DHCP server in this way otherwise conflicts may occur.

Power Main Unit

Connect the supplied 12V 10A power supply to the 4pin XLR DC Power Input on the rear of the Main Unit. The power supply should be connected to a suitable mains electric outlet using the supplied mains cable. A case earth connector is also provided.

Control Panel

The Control Panel has a 4pin XLR DC In socket on the rear panel, and a 12v 5A power supply is supplied. A case earth connector is also provided.

There are two power ON/OFF switches to look at on the SE-3000, one on the Main unit and another on the Control Panel / Keyboard. Start the Main unit first and then the Control Panel.



Main Unit On / Off Switch



Control Panel On / Off Switch

Video Connections

SDI Video Inputs

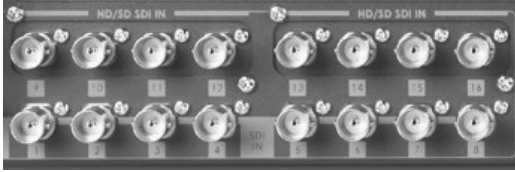

Looking at the rear panel of the SE-3000 Main Unit, the lower row of HD-SDI inputs are labelled 1~8 and the upper row of SDI HD/SD inputs are labelled 9~16. If your unit only has 8 inputs then the upper row of BNC connectors will not be present.

Units with only 8 inputs can be upgraded to 16 inputs, please speak with your local Datavideo supplier for upgrade availability and price.

Inputs 9~16 can be used to input **Standard Definition** or **High Definition SDI sources** depending on the **INPUTS** setting for each – See **Input Channels 9~16** on the following page.

Inputs 1~8 can only accept **High Definition SDI sources** with the exception of input 8 – See **DVI Input – Input 8** on the following page.

Setting the Resolution of the SE-3000

The SE-3000 has six standard HD resolution settings. To set the mixer's resolution press the **SETUP** button in the **Menus** button group of the SE-3000 Control Panel / Keyboard.



Now look at the Touch Screen Menu Panel and in the bottom left hand corner is the **Standard** option. Tap on the current resolution displayed and a list of six options is shown.

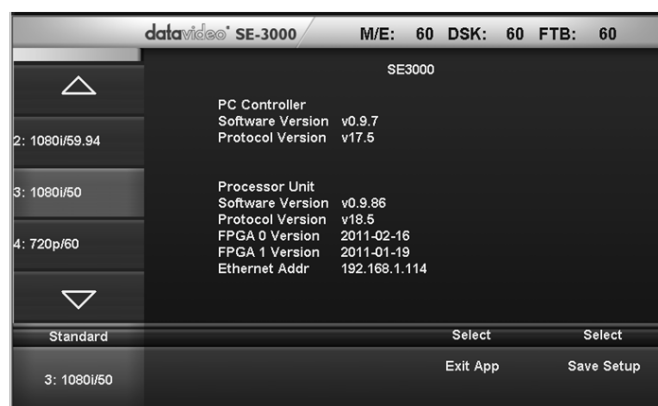

Use the up and down arrows to see each of the options available then tap on the resolution required. The list should now disappear leaving the chosen standard displayed. Any connected monitors should now identify and sync with the new resolution now being output by the mixer.

Standard resolutions are:

1920x1080i 60, 1920x1080i 59.94, 1920x1080i 50, 1280x720p 60, 1280x720p 59.94 and 1280x720p 50.

DVI Input – Input 8

NOTE: When the DVI Input option is enabled HD-SDI input 8 is replaced with the DVI input source video. On the MultiViewer output, the name of input 8 is changed to 'DVI Input'

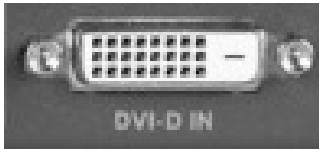

The DVI input can be set to accept computer DVI-D inputs at resolutions of 1280x720, 1024x768 or 800x600 depending on the graphics capability of the Computer or Laptop connected. However, it is best to supply video inputs that match the resolution of the mixer where possible.

Use the **INPUTS** button from the **Menus** button group of the SE-3000 Control Panel / Keyboard then look at the Touch Screen Menu Panel. Tap on **DVI Input** and then tap below **Enable** so it displays as **On**.



HDMI sources could be connected here using a DVI-D to HDMI cable. Avoid using sources with HDCP protected video.

Input Channels 9~16

NOTE: Units with only 8 inputs can be upgraded to 16 inputs, please speak with your local Datavideo supplier for upgrade availability and price.

Inputs 9~16 can be used to input **Standard Definition** or **High Definition** SDI sources depending on the **INPUTS** setting for each. Press the **INPUTS** button in the **Menus** button group of the Control Panel / Keyboard. Now look at the Touch Screen Menu Panel.

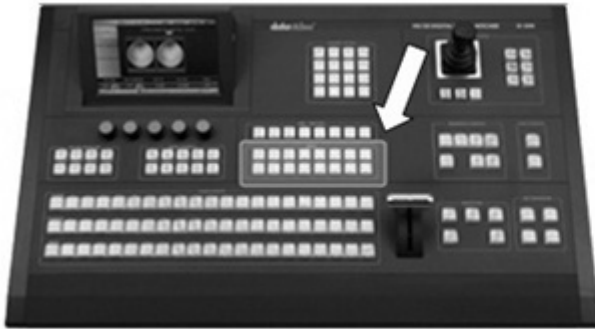

Tap on **Inputs** and then tap on the required input channel number. For our example we have chosen Input 9 and changed it to accept an SD-SDI 16:9 or *Anamorphic* video input by using the **SD Full Screen** option.



Please note that **SD Full Height** and **SD Full Width** can be used with 4:3 aspect video.

SD Full Height will show black columns at either side of the 4:3 video.

SD Full Width will show black bars above and below the 4:3 video.

HD Input returns the channel to an HD-SDI input.

Video Outputs

The SE-3000 has many video outputs which include:

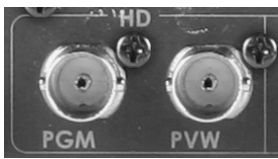

HD-SDI Program (PGM)

HD-SDI Preview (PVW)

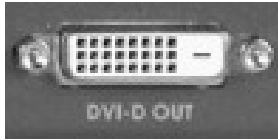

DVI-D Output user assigns as either

- PGM**
- PVW**
- PGM DSK1**
- PVW DSK1**
- Multiview 1**
- Multiview 2**

To assign the type of output required for the DVI-D output press the **OUTPUTS** button in the **Menus** area of the Control Panel / Keyboard. Then tap on **DVI Out** and choose one of the six options above.

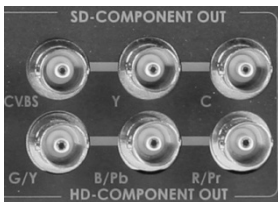

SD YPbPr SD Component Output

HD YPbPr HD Component Output

HD Output user assigns as either

- PGM**
- PVW**
- PGM DSK1**
- PVW DSK1**
- Multiview 1**
- Multiview 2**

To assign the type of output required for the Analogue output press the **OUTPUTS** button in the **Menus** area of the Control Panel / Keyboard. Then tap on **Analog Out** and choose one of the six options above. This Analogue output has a further setting for **YPbPr** or **RGB** output depending on your connected equipment.

Auxiliary HD-SDI Outputs 1~4

It is possible to delegate any SE-3000 video input to any one of the four Auxiliary HD-SDI Outputs. These outputs can be really useful as it allows a production team options to place a small HD-SDI monitor (such as the 7" TLM-700HD) in a speakers lectern or send looped video from a HDR-50 recorder to monitors just outside the live event area to attract people in.

How to assign Auxiliary Output sources

The SE-3000 **AUX BUS** button row makes it easy to assign a source to an Auxiliary HD-SDI Output.



Simply press the AUX button required and then select the source from the AUX BUS Row of buttons.

Monitor Connections

Multi Image Preview

It is possible to operate the SE-3000 with just one or two monitors connected. The Multi Image Preview can be supplied from a combination of the **Multi-1 HD-SDI**, **Multi-2 HD-SDI** or **DVI-D** output. Using one or two of these outputs you can display all inputs plus next source Preview and Program output as well as selected image Stills 1 and 2.

The Multi Image Preview will also confirm basic tally information on these screens too by highlighting the live source image with a red border, and the cued/next source image with a yellow border.

If the Multi Image Preview is supplied from the **Multi-1, Multi-2 outputs** (see page 11), then two Datavideo TLM-170H monitors could be used. Alternatively you could use two Datavideo DAC-8 converters to change HD-SDI signals to HDMI and then feed these signals to two compatible LCD / LED panels of your choice.

If the Multi Image Preview is supplied from the **DVI-D output** connection, a DVI-D to HDMI cable could be used. **Please ensure your chosen DVI-D or HDMI monitor is able to accept the mixers output resolution, for example 1920x1080@60Hz.**

Multi Image Preview – Initial Set Up

The Multi Image Preview can be displayed in 5 different user selectable layouts.

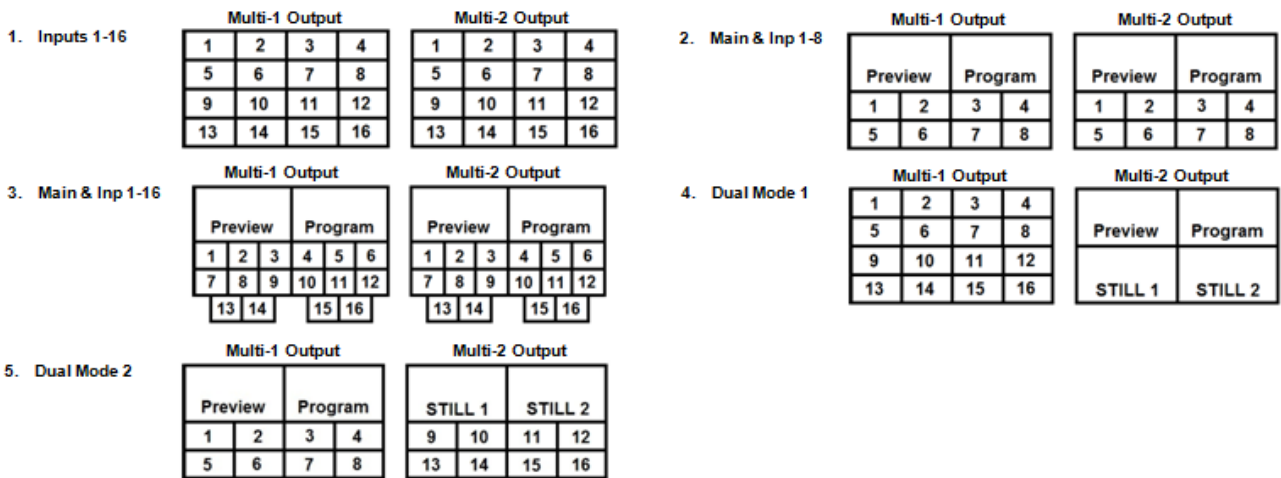

To configure the layout press the **OUTPUTS** button in the **Menus** button group of the SE-3000 Control Panel / Keyboard.



Now look at the **Touch Screen Menu Panel** and tap on the word **MultiViewer** in the yellow options area.

The bottom of the screen now shows the menu options for MultiViewer and the first option is also called **MultiViewer**. Tapping on this option in the bottom left hand corner displays the list of 5 layout options.

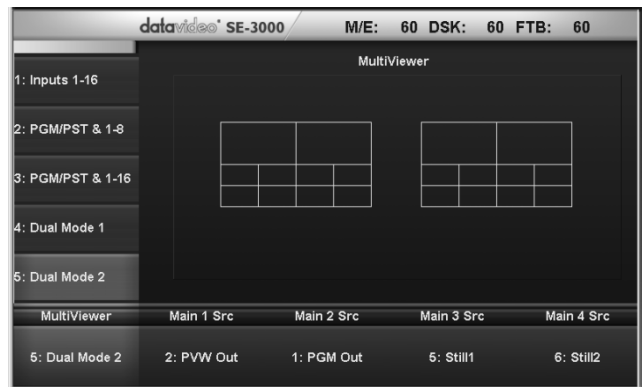
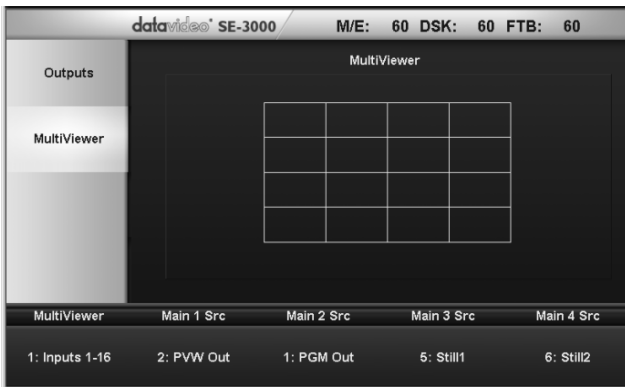

Modifying the chosen MultiViewer Layout

It is advisable to have the Multi Image Preview displayed on the Preview monitor(s) first so that you can see the effect of the following settings as you change them.

Changing Main Screens 1~4

To make things easier to understand we shall use the **Dual Mode 2** MultiViewer option as an example. The method involved in changing Main Screens 1~4 here is the same for the other MultiViewer set ups.

Multi-1 Output				Multi-2 Output			
MAIN 1 SCR		MAIN 2 SCR		MAIN 3 SCR		MAIN 4 SCR	
Preview		Program		STILL 1		STILL 2	
1	2	3	4	9	10	11	12
5	6	7	8	13	14	15	16

When you look at the initial layout of **Dual Mode 2 (above)** you can see that the top two images in both screens are; Preview, Program for the Multi-1 Output, and Still 1, Still 2 for the Multi-2 Output. When looking at the MultiViewer options below you will see 4 user options along the bottom of the Touch Screen. These are **Main 1 Src**, **Main 2 Src**, **Main 3 Src** and **Main 4 Src** and immediately below each will be their current setting.

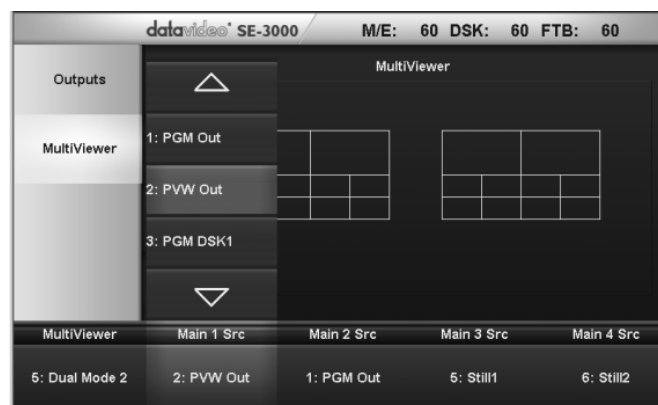

Touch the Menu Panel below the **Main 1 Src** option and a list of options becomes available. So here you have the ability to swap the larger MultiViewer screens around or use other options such as **PGM DSK1**. Play around with these settings and see which combination meets your production needs best.

Modifying the Multi Image Preview Labels

The 16 input channels, shown on the Multi Image Preview, are initially labelled **Input 1** to **Input 16** by default. These labels can be changed to suit your needs. For example you may want to use the names of the crew, or label a channel "B-Roll" or "Attract Loop". The label text can be up to 16 characters long.

It is best to have the Multi Image Preview on the monitor(s) so that you can see the effect on a chosen label.

Example: To modify the label for Input 1 press the **INPUTS** button in the **Menus** button group of the Control Panel / Keyboard.



Now look at the Touch Screen Menu Panel and **tap on the number 1**. The Touch Screen will change and in the bottom right hand corner there is a **Change Name** option, tap on this.

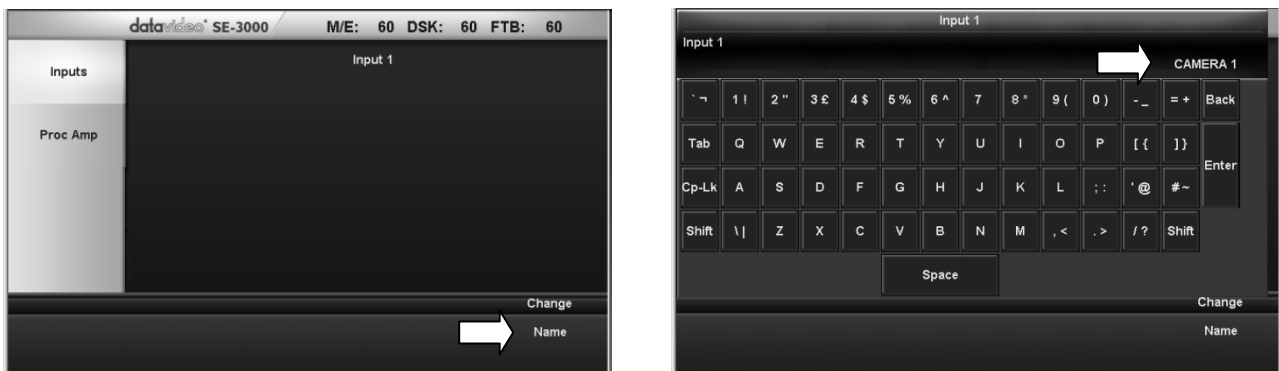

An onscreen keyboard is now displayed. At the top of the onscreen keyboard area the current label is shown twice, once in Yellow text on the left and also a little lower to the right hand side in White text.

Tap on the keyboard's **BACK** button and you will see the text in White above being deleted. Once deleted type in the new label for this input and then **ENTER**. The onscreen keyboard will disappear and your new label should now be present within the current Multi Image Preview.

Source Select Button Group

This group has three identical rows of buttons and is used to assign sources or select images for Program or Preset (Next source) outputs. The buttons are labelled left to right as Black, sources 1 to 16, Matte, Flex, Still and Shift.



Aux Bus – Top Button Row

This row of buttons is typically used to assign sources when setting up Auxiliary Monitors and the Flex output, as well as the set up of the Linear, Chroma and Luma Keyer functions.

Program – Middle Button Row

This row of buttons is typically used to select the mixers main Program output image. The currently selected source being sent to the Program outputs will be **backlit Red** on this row. Simple cuts between sources can be performed on this row by pressing on the source number required for the next shot.

Preset – Bottom Button Row

This row of buttons is typically used to select the mixers Preview or Next source output image. The currently selected source will be **backlit Green** on this row. When transitioning between sources using the T-Bar the selected Preset/Next source button will change from Green to Yellow.

Transitions Group

The **Transitions** group of buttons allows the user to decide how to bring the selected Preset / Next source image to the Program output. The SE-3000 user can decide to use a **CUT, MIX, WIPE** or **DVE** transition. In order to use these transition options the **BGND** (Background) Button needs to be backlit Green in the **Transition Controls** area of the SE-3000 Control Panel.



AUTO TRANS Button

The **AUTO TRANS** button is used instead of the manually operated **T-Bar** and automatically performs the complete selected transition between Program and Preset over a set period. The **ME TRANS** value in the **HOME** menu is used here. See **Home Menu** on page 25 also.

CUT Button

The **CUT** button is used to immediately switch between the currently selected Program and Preset sources.

MIX Button

The **MIX** button is selected when a dissolve or fade transition between the selected Program and Preset sources is required. This **MIX** transition is produced by then moving the **T-Bar** manually or by pressing the **AUTO TRANS** button.



WIPE Button

The **WIPE** button is selected when a 2D wipe effect transition between the selected Program and Preset sources is required. This WIPE effect is produced by then moving the **T-Bar** manually or by pressing the **AUTO TRANS** button.

DVE Button

The **DVE** button is selected when a 3D DVE transition between the selected Program and Preset sources is required. This DVE transition is produced by then moving the **T-Bar** manually or by pressing the **AUTO TRANS** button.

Previewing a selected transition

It is possible to see or test the effect of a chosen **MIX**, **WIPE** or **DVE** transition in the Preview Monitor before using it on the Program output.

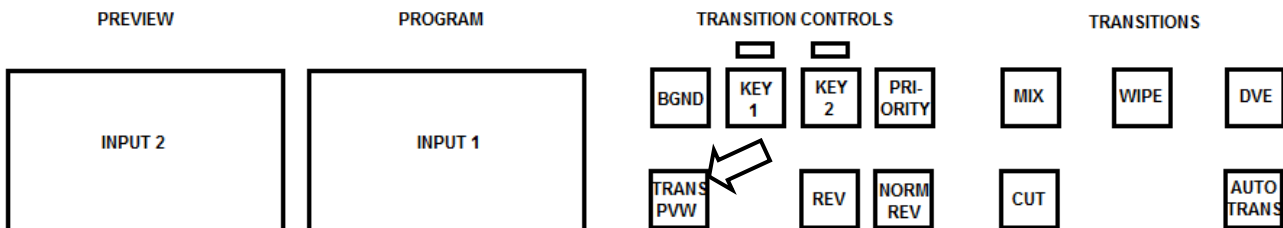

In order to do this look at the **Transition Controls** group of buttons on the Control Panel and below the **BGND** (Background) button is the **TRANS PVW** button. Once the **TRANS PVW** button is ON and backlit Green, select and use the transition that you want to test on the Preview monitor. You will also notice that the Preview Monitor switches to the currently selected Program source when the **TRANS PVW** button is turned on. Do not worry, the chosen Preset source has not changed. Press the **AUTO TRANS** button or move the **T-Bar** manually to preview the chosen transition.

NOTE: Remember to turn off the TRANS PVW button before attempting to use the chosen transition on the Program output.

REV and NORM / REV buttons

When the **REV** and **NORM / REV** buttons are **OFF** the selected WIPE or DVE transition will operate in its default direction only.

When the **REV** button is **ON** then the selected transition will operate in the reverse direction only.

When the **NORM / REV** button is **ON** the selected WIPE or DVE transition will automatically switch directions as each transition is completed. The **REV** button will switch on and off automatically to indicate the direction of the next transition.

WIPE Selection Menu

There are 30+ different WIPE effects to choose from when using the SE-3000 mixer. Each WIPE transition also has flexible user options to tailor the look of the transition.

Example: To select a different WIPE transition, press the **WIPE** button in the **Menus** button group of the Control Panel / Keyboard. Ensure the **WIPE** and **BGND** buttons are ON see page 20 **Transitions Group**.



Now look at the Touch Screen Menu Panel. A page of 16 WIPE Icons is displayed.

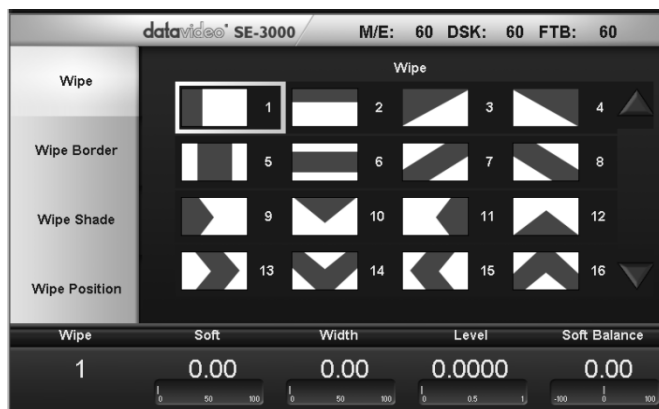

The yellow menu area on the left of the Wipe Main Menu screen shows the different parts of the Wipe set up. These are **Wipe**, **Wipe Border**, **Wipe Shade** and **Wipe Position**. Along the bottom of the initial **Wipe** display are options for **Wipe Number**, **Soft**, **Width**, **Level** and **Soft Balance**.

Each WIPE Icon is blue and white. White represents the current Program image and Blue represents the Preset / Next source image. The shape and edges of these White and Blue areas within each Icon gives an idea of what the selected wipe will look like when used on screen. Use the Arrow Up and Down Touch Screen buttons to the right of the Icons to display the next page of wipes or the previous page.

It is possible to see or test the effect of a chosen **WIPE** transition in the Preview Monitor before using it on the Program output. See **Previewing a selected transition** on page 21.

Wipe

To select a WIPE tap on an Icon or tap on the Wipe number in the bottom left hand corner and then enter a wipe number using the keypad. The current or selected WIPE will have a Yellow border.

Soft Value

This value softens the leading and trailing edge (A+C) of the wipe as shown in the diagram right. A low value makes a sharp or hard wipe edge. A large value results in a softer or diffused wipe edge.

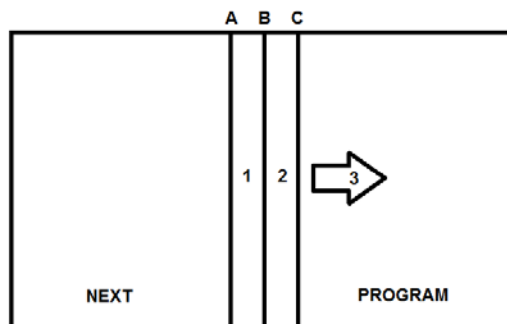

Width Value

This value determines how wide the actual wipe effect is. A low value makes a narrow wipe (A and C move closer together). A large value makes a wider wipe (A and C move further apart). A value of 10 would relate to the wipe being 10% of the width of the screen.

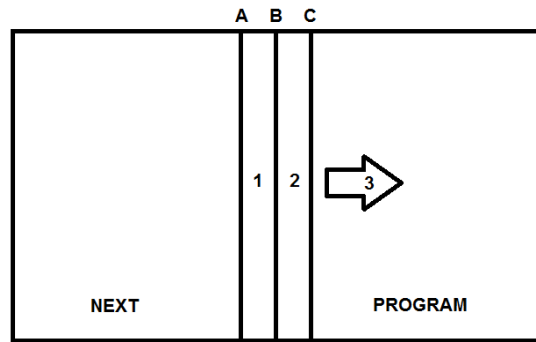

Level Value

This value relates to how far the wipe has travelled across the screen and changes as the **T-Bar** is moved or the **AUTO TRANS** feature progresses.

Soft Balance

This value allows the 'inside' and 'outside' edge softness of the Wipe Border to be controlled. If the Soft Balance is set to zero then both the Inside and Outside edges of the wipe have the same softness, as set by the 'Soft Value'

If the Soft Balance is set to a positive number, then the inside edge (A) is made softer.

If the Soft Balance is set to a negative number, then the outside edge (C) is made softer.

Wipe Border

The **Wipe Border** options and values are currently shown along the bottom of the display below.



The Wipe Border Menu allows control of the Wipe Border Matte.

Colour Palette

The Colour Palette allows selection of a colour for the Wipe Border Matte. Tap on the Colour Palette and the crosshair + shows the currently selected colour which is also confirmed under the RGB values on the right.

Hue, Sat and Luma values

The colour of the Wipe Border Matte can also be controlled by adjusting the **Hue**, **Sat** and **Luma** values. These values can be fine tuned by using the **F1-F3 Function Dials** just below the Touch Screen.

Source Control

When branding a production a source/image related wipe can become very useful. Instead of using a colour for the Wipe Border, a video source or still could be used instead. Then as the wipe moves along the screen the image source is partially revealed across the path of the wipe.

Tapping on the **Source** Control displays a list of 10 options for the Wipe Border source. Use the Arrow Up and Down buttons to scroll through the list then tap on the required source. Available options are **Single Colour Border**, **Shaded Border (Dual Colour)**, **Still 1**, **Still 2** or an **Input** from **1 to 6**.

Wipe Shade

Note: In order for the **Wipe Shade** effect to work, **Shaded Border (Dual Colour)** must be selected first as the **Wipe Source** value – see the previous section **Source Control**. The **Wipe Shade** options and values are currently shown along the bottom of the display below.

The Wipe Shade Menu allows control of the Wipe Shade Matte.



Colour Palette

The Colour Palette allows selection of a colour for the Wipe Shade Matte. Tap on the Colour Palette and the crosshair + shows the currently selected colour which is also confirmed under the RGB values on the right.

Hue, Sat and Luma values

The colour of the Wipe Shade Matte can also be controlled by adjusting the **Hue**, **Sat** and **Luma** values. These values can be fine tuned by using the **F1-F3 Function Dials** just below the Touch Screen.

Shade Soft

This blurs or softens the boundary line (B) between the Wipe Shade Matte (area 1) and the Wipe Border Matte (area 2).

Shade Position

The position of the boundary line (B) between the two matte wipe colours (1+2) is controlled by the **Shade Position** value.

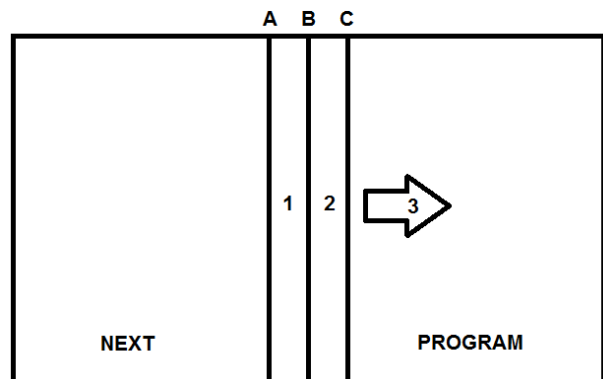

A positive value moves the boundary line so that the Wipe Shade Matte (area 1) occupies less of the width of the wipe. A negative value moves the boundary line so that the Wipe Shade Matte occupies more of the overall wipe width.

Wipe Position

Certain Wipes, such as the **Circle** and the **Oval Wipes**, allow the Wipe position to be controlled. The **Wipe Position** options and values are shown along the bottom of the display.

The **X value** allows the selected wipe to be offset to the left or right of the screen.

The **Y value** allows the selected wipe to be offset to the top or bottom of the screen.

The **Rotation value** allows the Oval wipes to be angled too.

In this way, some pleasing Wipe or Border effects can be created.

DVE Transitions Menu

There are over 80 different DVE Transitions to choose from when using the SE-3000 mixer.

Example: To select a different DVE Transition, press the **TRANS** button in the **Menus** button group of the Control Panel / Keyboard. Ensure the **DVE** and **BGND** buttons are ON see page 20 **Transitions Group**.



Now look at the Touch Screen Menu Panel. A page of 16 transition Icons is displayed.

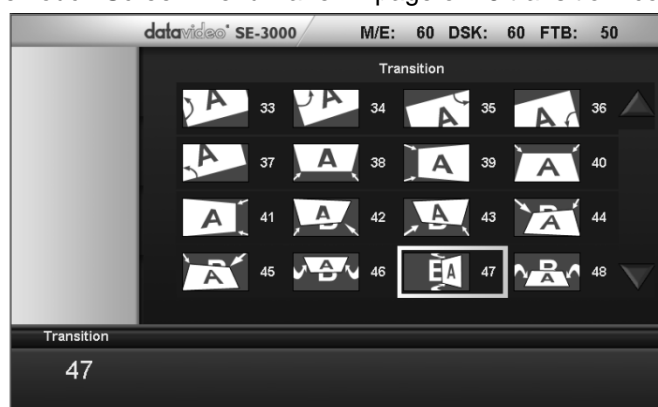

Each **TRANS** Icon is blue and white. White represents the current Program image and Blue represents the Preset / Next source image. The shape and edges of these White and Blue areas within each Icon gives an idea of what the selected DVE transition will look like when used on screen. Use the Arrow Up and Down Touch Screen buttons to the right of the **TRANS** Icons to display the next page or the previous page.

It is possible to see or test the effect of a chosen **DVE** transition in the Preview Monitor before using it on the Program output. See **Previewing a selected transition** on page 21.

Transition Selection

To select a DVE transition tap on an Icon or tap on the transition number in the bottom left hand corner and then enter a number using the keypad. The current or selected DVE transition will have a Yellow border.

Home Menu – Length of Transition

Press the **HOME** button in the **Menus** button group of the Control Panel / Keyboard. Now look at the Touch Screen Menu Panel. There are 3 options across the bottom of the Touch Screen. These are **ME**, **DSK** and **FTB Trans**. The values below each of these transition options relate to the length of the transition in **frames**.

ME Trans

Is the value used by the **AUTO TRANS** button when using a **MIX**, **WIPE** or **DVE** transition between Program.

DSK Trans

Is the value used by the **DSK Transitions** button group when mixing between two different DSK sources.

FTB Trans

Is the value used by the **FTB** or **Fade To Black** button when **Enabled**.

Freeze Menu

This menu allows a selected Input from 1 to 16 to be frozen so that a good **Stills Grab** can be captured from the input. The input to be frozen is best displayed on the **Program monitor** by selecting it on the Program source row. The video can then be seen and the image frozen at the correct point. **NOTE:** the **STILLS** grab feature only captures images from the Program output. See **STILLS Menu** on page 27 also.

Example: Press the **FREEZE** button in the **Menus** button group of the SE-3000 Control Panel / Keyboard.



Now look at the Touch Screen Menu Panel.



When the Freeze Menu is selected, Icons for all 16 input sources are shown. Tap or select the input you wish to Freeze. The Touch Screen will then change to show the Freeze options along the bottom of the screen.



Freeze On / Off

Tap on this option to toggle the freeze On or Off. The video will then be frozen as a full frame or field according to the chosen mode. **Remember** to turn the Freeze option off after you have finished using it.

Mode

The Freeze Mode can be set to a full frame or one field. If field is chosen then field 1 is repeated for both Fields (1 & 2).

Stills Menu

The Stills menu allows the user to Grab, Store and Load Uncompressed stills with the SE-3000 Mixer. This feature is generally used after the **Freeze** menu function, see page 26.

The Main unit has two frame stores to which stills can be loaded, and the unit has enough storage space for about 100 uncompressed stills.

It is best to have **Dual Mode 1** or **Dual Mode 2** Multi Image Preview on the monitor(s) so that you can see your Program output and any captured still images. See also **Multi Image Preview** on page 17.

Example: Press the **STILLS** button in the **Menus** button group of the SE-3000 Control Panel / Keyboard.



Now look at the Touch Screen Menu Panel.



Grabbing & Saving a Still to memory

The Grab & Save option allows new Still Images to be created by grabbing & saving the **current Program video frame image** to one of the two internal stills buffers in the SE-3000.

- The Program output is grabbed to a Stills buffer (Still 1 or 2) by pressing the 'Grab Still' option.

Multi-1 Output			
MAIN 1 SCR	MAIN 2 SCR		
Preview	Program		
1	2	3	4
5	6	7	8

Multi-2 Output			
MAIN 3 SCR	MAIN 4 SCR		
STILL 1	STILL 2		
9	10	11	12
13	14	15	16

- The user can then look at the Multi Image Preview and decide if this Still should be saved.
- To Save a Still from the currently selected Stills buffer, the user should select a Stills number that has not been used yet, and tap on the **'Save Still'** option.
- The save process takes about 15 seconds, after which the new thumbnail picture will be shown within the Stills display under the chosen stills number.
- In addition, a name or description for the Still can be added using the 'Name' option.

Loading an existing Still from memory

The Still Load Menu allows stills already stored in the SE-3000 to be loaded to either the Still 1 or Still 2 buffer.



The Still menu screen (shown above) shows thumbnail pictures of up to 16 saved stills at a time. If there are more than 16 stills stored in the SE-3000 then the Arrow Up and Down buttons on the right can be used to page up or down through the saved stills. The stills are shown in numerical order, and any numbers not used are not shown. The currently selected still is shown with a Yellow border.

To load a still, the user can either tap on the appropriate thumbnail picture, or select it by entering the Stills number and then tapping the '**Load Still**' option.

The selected still will be loaded into the currently highlighted stills buffer. In the above example still buffer 2 has been loaded with selected still number 3.

Deleting a saved Still from memory

To delete a saved still, tap on the thumbnail picture of the still that is no longer required. A yellow box will be displayed around the selected thumbnail. Now tap on the Delete option in the yellow menu area. Another Delete option is then shown at the bottom of the Touch Screen. Tapping on this second Delete option confirms that the selected still should be deleted from the SE-3000 memory.

Note: The deleted still is kept in the current Still 1 or 2 buffer until another still image is selected or grabbed to occupy this buffer.

Bus Matte Menu

The **Matte** Menu allows you to create a full screen colour background or **Bus Matte**. This background can then be used for keying or can be overlaid with Flex elements and any CG-350 PC generated graphics or text.

Example: Press the **MATTE** button in the **Menus** button group of the SE-3000 Control Panel / Keyboard.



Now look at the Touch Screen Menu Panel.



Colour Palette

The Colour Palette allows selection of a colour for the Bus Matte.

Tap on the Colour Palette and the crosshair + shows the currently selected colour which is also confirmed under the RGB values on the right.

Hue, Sat and Luma values

The colour of the Bus Matte can also be controlled by adjusting the **Hue**, **Sat** and **Luma** values. These three values can be fine tuned by using the **F1**, **F2** and **F3 Function Dials** just below the Touch Screen.

The **Hue** adjustment moves the crosshair + around the colour palette in a clockwise or anti-clockwise direction. The **Hue** value can be controlled by the **F1 Function dial**.

The **Sat** or Saturation value moves the crosshair + from the centre of the colour palette to the outer edge. The **Sat** value can be controlled by the **F2 Function dial**.

The **Luma** value relates to how bright or dark the selected colour is. The **Luma** value can be controlled by the **F3 Function dial**.

Storing and Recalling USER Set Ups

The **USER** menu button allows you to Store and Recall User Set Ups on the SE-3000. If you have standard configurations for your productions then this feature can save you a lot of time re-configuring the mixer after someone else has used it.

The SE-3000 allows up to 1000 User Set Ups to be stored, these are numbered 0 – 999.

How to quickly save a User Set Up

When you are happy with the way that you have configured the SE-3000 a snap shot of all current settings can be saved or stored into a chosen USER memory slot.

Example: To save the current mixer configuration press the **SAVE** button in the **Numeric Keypad** area of the SE-3000 Control Panel / Keyboard. Now press number **1** and then **ENTER** on this Keypad.



In the **USER / SHOT BOX** area of the Control Panel / Keyboard the number 1 button will now be backlit green indicating that it has user settings stored within this memory slot.

Labelling an existing User memory slot

In order to make the stored USER 1 easy to refer back to in the future then this User memory slot can also be labelled too. Press the **USER** button in the **Menus** area of the SE-3000 Control Panel / Keyboard. Now look at the Touch Screen Menu Panel.

The User Memories screen shows icons for up to 16 user memory slots at a time. The current or selected User slot will have a yellow border.

At the bottom of the screen in the right hand corner you can **select Name** to type in a label for the selected User memory slot. The label can be up to 16 characters long but only the first 10 letters are displayed in the User Memories screen.

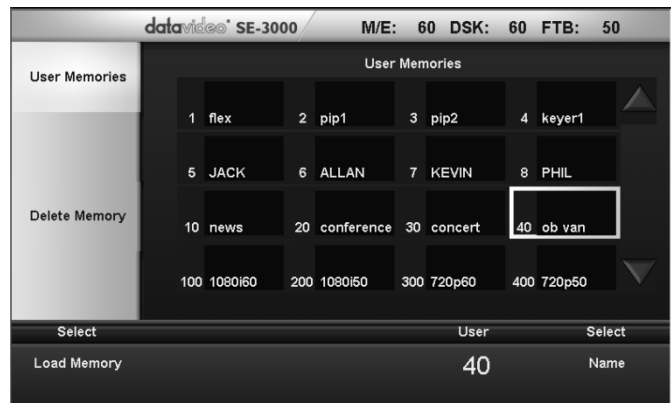

If there are more than 16 User setups stored in the SE-3000 then the Arrow Up and Down Touch Screen buttons to the right can be used to display the next 16 slots or show the previous 16 slots. The User memory slots are shown in numerical order, and any numbers not used are not shown.

Loading a previously saved User Set Up

Example: To load a previously saved mixer Set Up simply press the **LOAD** button in the **Numeric Keypad area** of the SE-3000 Control Panel / Keyboard. Now **enter the number of the required set up** and then press **ENTER** on this Keypad.



If the User set up was saved to one of the first 8 memory slots then you could press the relevant number in the **USER / SHOTS BOX** area of the SE-3000 Control Panel / Keyboard.

A third way to load a saved Set Up is to press the **USER** button in the Menu area of the SE-3000 Control Panel / Keyboard. Now look at the Touch Screen Menu Panel.

The User Memories screen shows icons for up to 16 user memory slots at a time. The current or selected User slot will have a yellow border.

At the bottom of the screen in the left hand corner you can **Load Memory** from the currently selected memory slot.

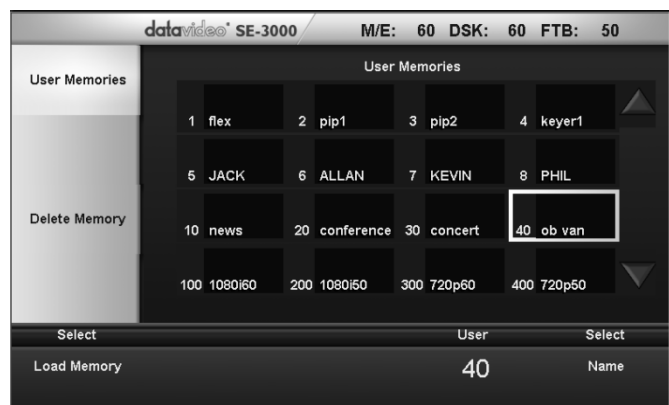

Deleting a User Set Up

To Delete an existing User Memory slot or Set Up select the Memory position using the Touch Screen Menu Panel. Then tap on the 'Delete Memory' option in the Yellow menu area. Confirm deletion of the selected User number by tapping on Delete at the bottom of the screen.

Flex™ Overview

The Flex™ output allows the user to show a variety of sources at the same time these can then be fed as one combined image to the SE-3000 Program, Preview and or Auxiliary outputs.

The Flex™ output could be as simple as one background image and a smaller second source image to make a basic PIP or Picture in Picture.

Alternatively it could be a lot more complex with a third image source making a second PIP window. You also have the ability to place a user defined colour border around the smaller PIP windows. You can re-size, crop, rotate and position the DVE / PIP windows in almost any manner that you wish.

Add to this the linear keying options for adding a **CG-350 text/graphics overlay** and your creative options are only limited by your imagination and skill with the SE-3000.

Flex™ screen order

The Flex™ screen is made up by laying different sources on top of each other. The following diagram shows the order of these layers. This may help you to understand how a particular layout would work in your production.

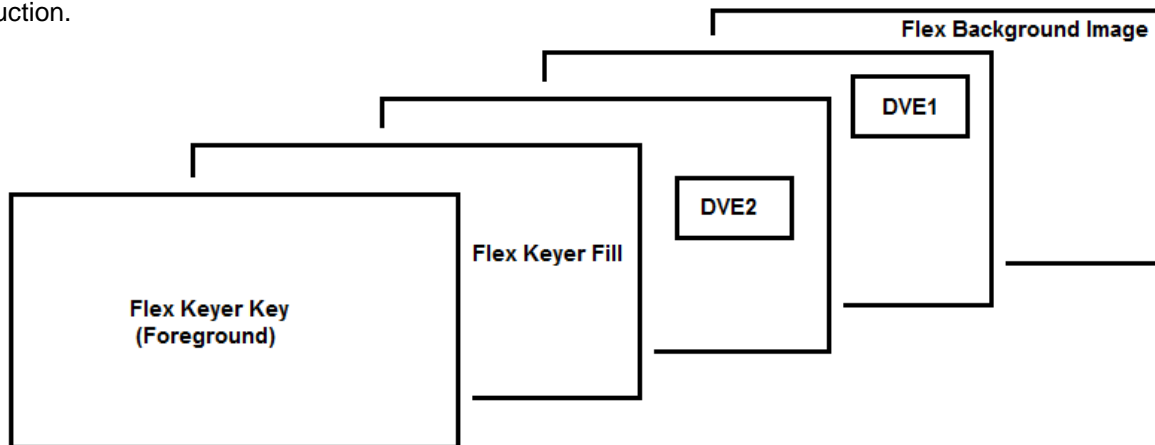

The Flex™ Source Keyer is a simple linear Keyer, which is layered over the background and DVEs. **No Lift, Gain or Opacity controls are provided.** This keyer is intended to be used with good **external key** and **fill** sources such as provided by the *Datavideo CG-350 PC*.

*It may be good idea to assign the Flex™ output to an Auxiliary monitor. Then use this full size Auxiliary monitor as a Flex™ preview screen so you can prepare your chosen Flex™ layout before displaying it on the preview or program outputs. See **How to assign Auxiliary Output sources** on page 16.*

Saving the Flex™ set up

Once you are happy with a Flex™ layout remember to **save your current user setup** (see page 30). In this way having several Flex layouts saved to different user memory slots allows you to switch one Flex layout to another quickly without having to worry about the re-sizing and placement of the DVE1 & 2 (PIP) windows.

Flex™ Set Up Menus

Example: Press the **FLEX** button in the **Menus** button group on the Control Panel / Keyboard.



Now look at the Touch Screen Menu Panel.

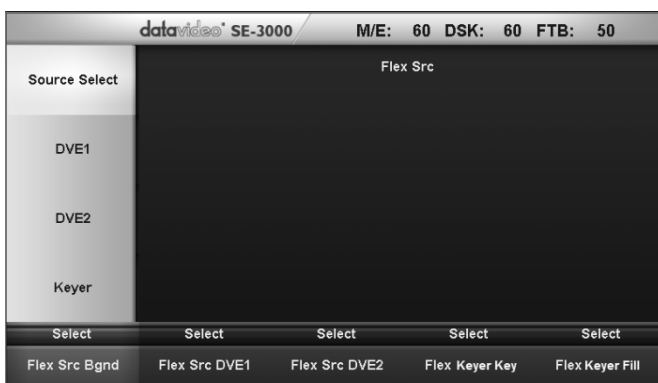

The yellow menu area on the left of the Flex Main Menu screen shows the different parts of the Flex set up. These are **Source Select**, **DVE1**, **DVE2** and **Keyer**.

Flex™ Source Select

Along the bottom of the initial Flex™ menu screen you can **select** a part of the Flex™ image and then **use the AUX BUS row of buttons** to assign a source.



Flex DVE1 (PiP1) and DVE2 (PiP2)

Tapping on DVE1 or DVE2 in the yellow menu area changes the Touch Screen Options. DVE1 or 2 can be set up as a PiP or Picture in Picture element of the Flex™ output.

Displayed options for DVE1 or 2 are **DVE Size**, **DVE Border**, **DVE Crop** and **DVE Position**.



DVE Position

The Position options and values are currently shown along the bottom of the display.

The Enable option in the bottom right hand corner toggles the currently selected DVE1 or DVE2 either **On** or **Off**. So you could switch DVE1 (PiP1) off and only have the background image and DVE2 (PiP2).

The Rotation value shows the amount of rotation that has been applied to the selected DVE1 or DVE2 image. The Flex Src DVE1 screen (above) has an image which shows the selected DVE (PiP) window in relation to the main background image. The larger box is the background image and the smaller box is the DVE (PiP) image. Over the top of the smaller DVE (PiP) box is an arrow which shows which way this image has been rotated. The arrow indicates the normal top edge of the DVE (PiP) image. If the arrow is pointing to the side then the DVE (PiP) image displayed in the Flex output will also be on its side.

Turning the **F4 Function Dial** next to the Touch Screen on the SE-3000 Control Panel will change the rotation value. Alternatively you could tap on the option within the Touch Screen Panel and then enter a value using the numeric keypad. Or you could **press the ROT button in the Joystick area** of the Control Panel and **then twist or rotate the joystick handle** in the direction required. Pressing the **FINE** button allows fine or small adjustments to be made. Press the **NORM** button and the selected DVE (PiP) image returns back to the factory default position and values. Use the **FLEX1** and **FLEX2** buttons in the joystick area to switch between adjustments of the DVE1 & 2 (PiP) images.

The X and Y values change the location of the DVE (PiP) image. The X value moves the image left and right. The Y value moves the image up and down. The DVEs in the Flex Source Processor are 2D DVEs, and do not allow the DVE (PiP) to be rotated in X, or Y, or have a Perspective feel.

The Z value changes the size and position of the DVE (PIP) image based on a zoom function. Increase the value Z and the selected DVE (PIP) image gets smaller and moves towards the centre of the screen. Reduce the Z value and the DVE (PIP) image gets larger and moves out away from the centre of the screen.

DVE Size

The DVE Size options and values are currently shown along the bottom of the display below.

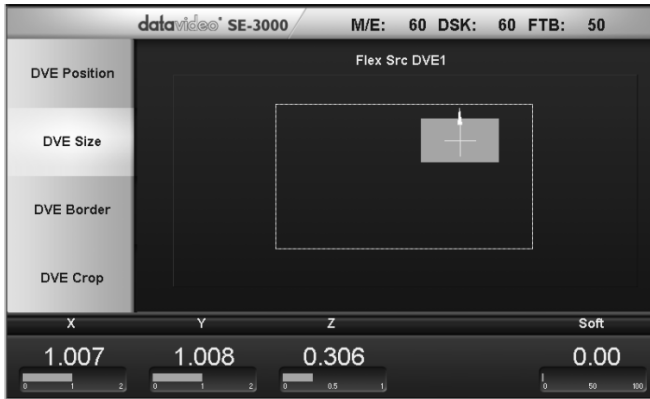

The X and Y values of DVE Size will either squash or stretch the selected DVE (PIP) image in a certain direction. The X value will move both sides of the image in and out affecting the width. The Y value will move both the top and the bottom of the image in and out affecting its height.

The Z value of DVE Size will maintain the aspect ratio of the original DVE image but either making the overall DVE image smaller or larger.

The Soft value of DVE Size will blur and soften the outside edge of the selected DVE (PIP) or border.

DVE Border

The DVE Border options and values are currently shown along the bottom of the display below.



Hue, Sat and Luma values define the DVE (PIP) border colour.

The **Hue** adjustment moves the crosshair + around the colour palette in a clockwise or anti-clockwise direction. The **Hue** value can be controlled by the **F1 Function dial**.

The **Sat** or Saturation value moves the crosshair + from the centre of the colour palette to the outer edge. The **Sat** value can be controlled by the **F2 Function dial**.

The **Luma** value relates to how bright or dark the selected colour is. The **Luma** value can be controlled by the **F3 Function dial**.

Size relates to the width or thickness of the colour border surrounding the selected DVE (PIP). The **Size** value can be controlled by the **F4 Function dial**. Increasing the value makes the border thicker but less of the selected DVE (PIP) image will be seen.

Soft will blur and soften the inside edge of the selected DVE (PIP) border. The **Soft** value can be controlled by the **F5 Function dial**.

DVE Crop

The DVE Crop options and values are currently shown along the bottom of the display below.



Left, Right, Top and Bottom edge crop values are changed using the **F1~F4 Function Dials**. As a dial is turned to the right the selected outside edge of the current DVE (PIP) will be cropped or lost.

The Size value crops all outside edges of the selected DVE (PIP) at the same time and at an even rate. The **F5 Function Dial** sets this value.

Flex™ Keyer Menu

Example: Press the **FLEX** button in the **Menus** button group on the Control Panel / Keyboard.



Now look at the Touch Screen Menu Panel.



Tapping on **Keyer** in the yellow menu area changes the Flex menu options, as shown on the left.

There are 3 options, **Flex Keyer Key** (Foreground selection), **Flex Keyer Fill** (Background selection) and **Flex Keyer Enable**.

Tapping on **Flex Keyer Key (Foreground)** and then selecting a source button from the **Aux Bus Row** assigns an input source image as the **Key**.

Tapping on **Flex Keyer Fill (Background)** and then selecting a source button from the **Aux Bus Row** assigns an input source image as the **Fill**.

Tapping on **Flex Keyer Enable** simply toggles this keying feature **On** or **Off**.

Note: The Flex Keyer provides a simple linear Keyer, which is layered over the Flex background and DVEs. **No Lift, Gain, or Opacity controls are provided**, as this keyer is intended to be used with good external Key and Fill sources.

Flex™ Key and Fill Example CG-350 Set Up

An example set up for the **Flex™ Keyer** feature would be to supply separate HD-SDI **Key** and **Fill** signals from a **Datavideo CG-350 PC**. This PC can provide CG overlays of text and graphics via the outputs of a 3rd party PCIe video card such as **Blackmagic Design's Decklink HD Extreme 3D+**.

First ensure the CG-350 software is set up for **External key** in settings.

The **Key** signal from the Decklink card is then fed to **input 15** on the SE-3000 (see diagram below). Tap on **Flex™ Keyer Key** (Foreground) and then select **button 15** from the **Aux Bus row** on the Control Panel.

If the **Fill** signal from this card is fed to **input 16** then you would tap on **Flex™ Keyer Fill** (Background) and then select **button 16** from the **Aux Bus row**.

Look at a Preview of the Flex™ output on a Preview/Auxiliary monitor. Tap on **Flex™ Keyer Enable** to turn the keyer **ON**.

If everything is cabled correctly (as shown below) then you should be able to see the output from the PC/CG-350 software on top of the Previewed Flex images.

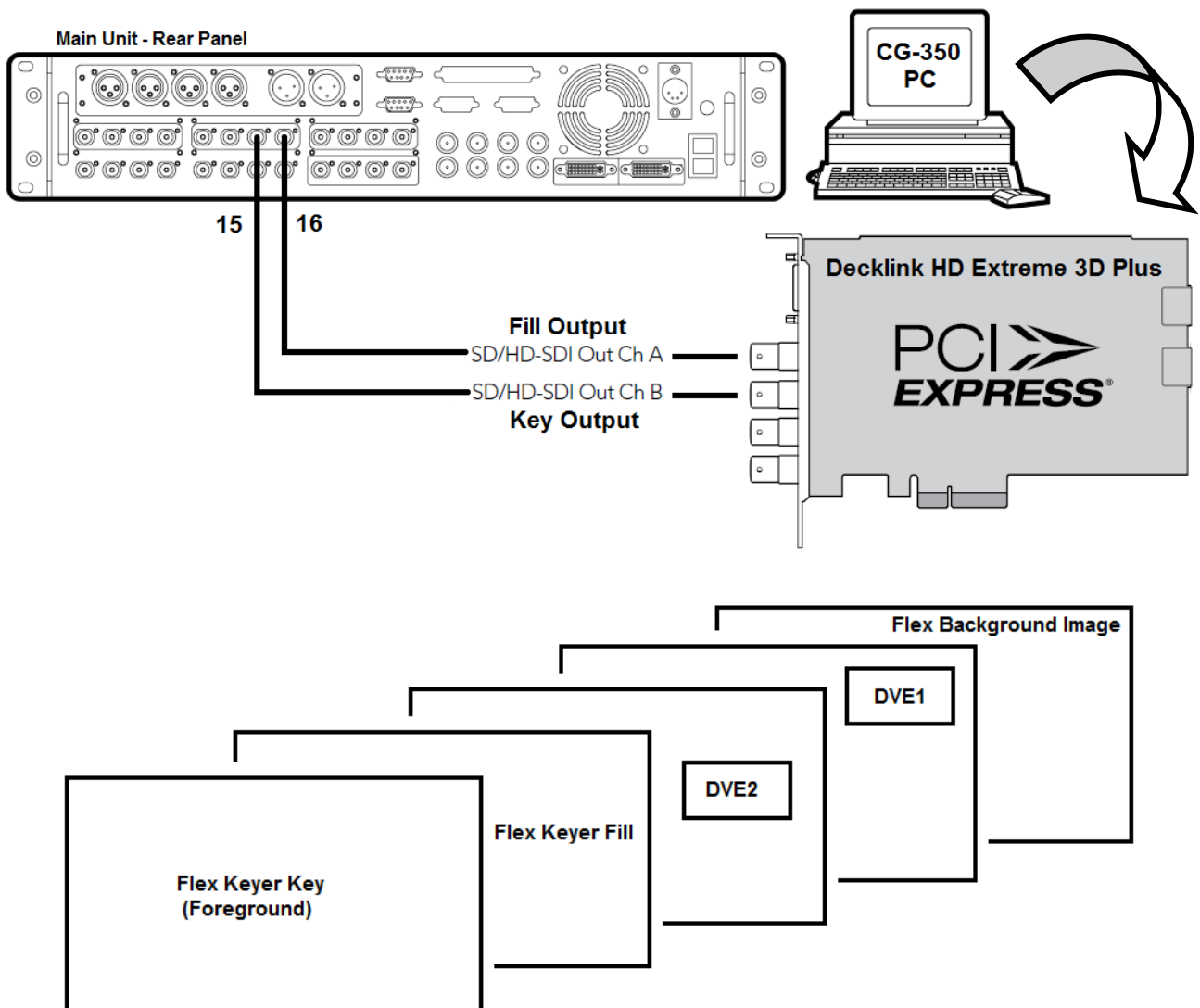

Chroma Key Overview



The Chroma Key feature of the SE-3000 is really easy to use. Typical Blue and Green screen studios can be quickly incorporated into an SE-3000 production.

First we will go over some basics, the **Control Panel buttons** and finally **a simple green screen example** set up. For those of you who need a quick reminder here are a few Chroma Key basics.

A good foreground image helps produce a good key

The **camera, backdrop** and **lighting** setup will all play an important role in producing the best Chroma Key result. Although the SE-3000 is equipped with excellent keying controls it is always best to start with the best keyable image that your setup is able to produce.

Three Chip Camera

We strongly recommend the use of a three chip (or CCD) camera for Chroma Key shooting. The extra image clarity and the good colour separation that a three chip camera produces really does improve the quality of the keying later on.

Do not mix SD and HD standards when keying

It is best to avoid trying to use standard definition SDI green or blue screen footage with a HD background because the keying edges in the SD image will become fuzzy during the SD to HD upscaling process. If you have a full HD background then for best results work with a full HD camera for the foreground too.

White Balance the Camera

White Balance is extremely important when setting up a chroma key studio. The camera must be correctly white balanced to minimise the subject picking up any colour cast from the background. Of course the white balance settings will vary according to the type of lighting you are using, but neutral whites and good skin tone colour are the all important target.

To set the white balance you will need a white reference card (or a sheet of white paper). Focus the camera on the reference card and light it evenly using the main light. Set the camera's iris / aperture so that the card is correctly exposed. Use the Auto White Balance (AWB) function, or set the white balance manually so that the card appears white. If you are in any doubt about how to white balance your camera, **please refer to your Camera's instruction manual for more details.**

Lighting

Lighting of your chosen green or blue backdrop is extremely important; the more even the lighting on the backdrop the better the finished result. Lighting setups for the foreground subject will vary according to the effect that you want. For chroma keying backdrops even lighting with no hotspots or shadow areas is the aim. This is easiest to achieve with a set up something like this:

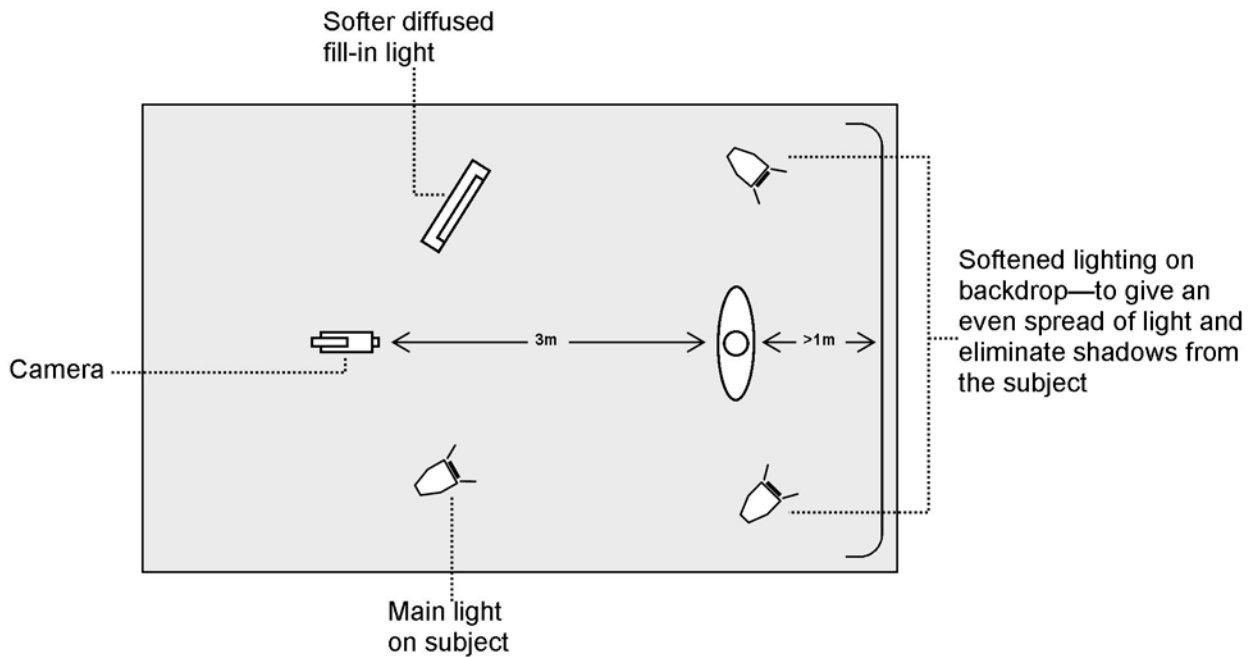

In the diagram you will see we recommend a minimum of 1m between subject and backdrop. It is always easier to get more even lighting if the subject is further away from the backdrop. The foreground lighting on the subject will obviously vary according to the effect that you are looking for and as long as the backdrop is evenly lit this should not be a problem.

Control Panel Button Groups used

To Chroma Key with an input source the following button groups are used on the SE-3000 Control Panel.



Key 1 and **Key 2** Buttons – These 2 keying channels can be used with typical Green or Blue screen set ups. The selected button or keyer that you are working with will be backlit Green.



The **Chroma** button in **Keyer Controls** is used to define the type of key set up. For example if you wanted to Luma key then you would choose the Luma button instead. The **On** button toggles the selected keying effect On or Off.



The **Chroma** button in the **Menus** button group brings up the Chroma Key options on the Touch Screen Menu Panel.

Chroma Key Quick Set Up

For this example we will be supplying the SE-3000 with a HD-SDI Green screen foreground video on **input 10**. We will select the **Flex** button on the Program source row and this will act **as the background video** for our key. So our green screen subject / presentator will be talking to camera but in the background there will be two Flex PIPs and a virtual studio loop as the Flex background. For **Flex information** see pages 31~36.

Step 1: Choose the Keyer channel that you want to use. For our example we will press the **Key 1** button in the **Aux Bus Delegates** button group.



Step 2: Choose the type of Keyer you want to use. In our example we will press the **Chroma** button in the Keyer Controls button group.



Step 3: Select the foreground video source to be keyed. In our example we want to use a green screen source connected to Input 10. So we would press **button 10** on the **Aux Bus Row** so it is **backlit Green**.



Step 4: Turn the keying effect on. Press the **On** button so it is backlit green. In our example you will now see the selected source **button, 10**, on the **Aux Bus Row** change so it is **now backlit Red**.



Step 5: Make some initial adjustments to the key. Press the **Chroma** button in the **Menus** button group and look at the Touch Screen Menu Panel.

Choose **Quick Setup** from the Yellow menu bar on the left of the Touch Screen.

The options along the bottom of the Touch Screen will now allow you to **quickly calibrate for a basic green or blue key**.

You can then move on to **fine tune the key** using the **Chroma Key Ctrl** and **Color Spill** options.

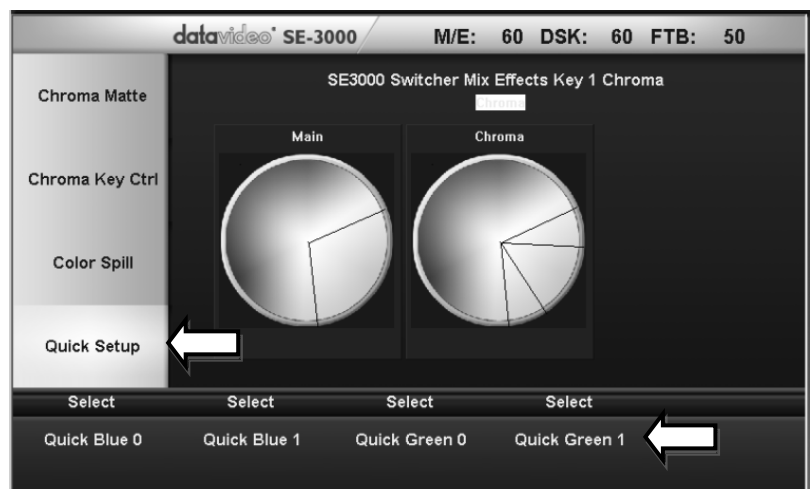

Chroma Matte

This matte sets the centre of colour range that will be used for keying. The **Chroma Matte** options and values are currently shown along the bottom of the display below.

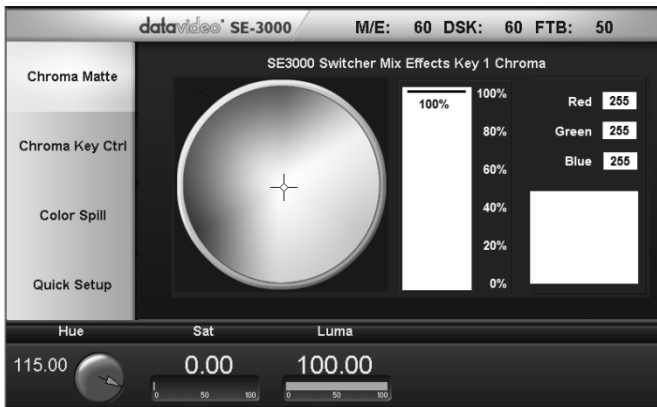

The **Hue** adjustment moves the crosshair + around the colour palette in a clockwise or anti-clockwise direction. The **Hue** value can be controlled by the **F1 Function dial**.

Certain colour hues can be found at certain angles on the colour palette. For instance, Red is 0 degrees (12 o'clock position), Green is approx 120 degrees (4 o'clock position) and Blue is approx 240 degrees (8 o'clock position). Secondary colours are Yellow at 60 degrees, Cyan at 180 degrees and Violet at 300 degrees.

The **Sat** or Saturation value moves the crosshair + from the centre of the colour palette to the outer edge.

The **Sat** value can be controlled by the **F2 Function dial**. If the **Hue** angle is set at 120 then the **Sat** value determines how much Green is in the matte.

The **Luma** value relates to how bright or dark the selected colour or hue is. The **Luma** value can be controlled by the **F3 Function dial**.

Chroma Key Ctrl

The **Chroma Key Ctrl** options and values are currently shown along the bottom of the display below. There are two colour palettes **Main** and **Chroma** shown. The **Main** palette can be referred to when changing the **Key Acceptance** and **Key Lift** values. The **Chroma** palette is affected by the **Color Spill** settings.



Key Acceptance is represented on the **Main** Palette as a sector or area covering a range of hues or colours that closely match the background colour to be keyed as set in **Chroma Matte**.

A large value of 120 degrees could be used to begin with and then this value could be fine tuned up or down with the **F1 Function Dial** depending on the set up of the green or blue screen studio.

Key Lift is represented on the **Main** Palette as a line extending from the centre point in the direction of the Key Acceptance sector. This value affects the performance of the Chroma key in **dark or black areas**. If the dark areas of the video are becoming too transparent then applying more **Key Lift** may help depending on the set up of the green or blue screen studio. This value is fine tuned up or down using the **F2 Function Dial**.

Key Gain affects the performance of the Chroma key in **light or white areas**. If the light areas of the video are becoming too transparent then applying more **Key Gain** may help depending on the set up of the green or blue screen studio. This value is fine tuned up or down using the **F3 Function Dial**.

Color Spill

The **Color Spill** options and values are currently shown along the bottom of the display below. These settings are used to control/remove any unwanted Chroma Spill from the background onto the foreground. There are two sectors drawn on the **Chroma** palette, one represents the larger **Chroma Acceptance** range and the other a smaller **Chroma Suppress** range.

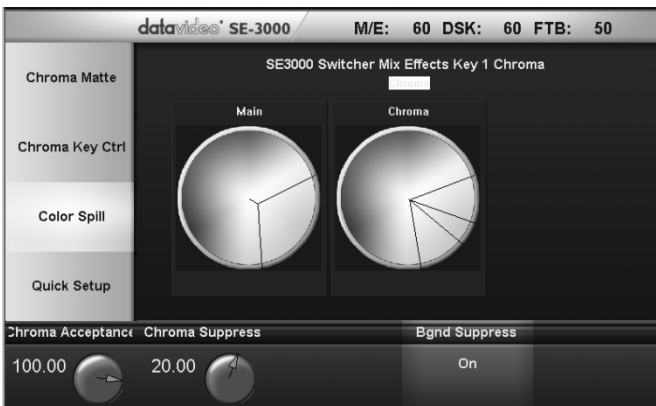

Chroma Acceptance sets how much of the available colour range or space should be **Chroma suppressed**. Usually starting with a large value of 120 degrees should produce reasonable results. This value can then be fine tuned up or down using the **F1 Function Dial** depending on the set up of your green or blue screen studio.

Chroma Suppress When set to 0%, this removes the hues or colours that lie only on the same axis as the **Chroma Matte** Hue angle, see

page 40. This setting has the effect of removing Background colour spill, but keeping the underlying hue. When set to 100% then all the Chroma values that are 'captured' within the Chroma **Acceptance Angle** are suppressed to mono – i.e. they have their Chroma removed. Usually starting with a value of 50% should produce reasonable results. This value can then be fine tuned up or down using the **F2 Function Dial** depending on the set up of your green or blue screen studio.

The **Bgnd Suppress** Control is used to remove the Luma (brightness) of the background from the final image. If the Chroma Key Output is showing Light Edges, then the **Bgnd suppress** can be used to suppress any background Luma that is showing through on these edges.

Saving the Chroma Key set up

Once you are happy with the Chroma Key set up remember to **save your current user setup** (see page 30). In this way having several Chroma Key set ups saved to different user memory slots allows you to switch from a Blue screen to Green screen set up quickly.

Luma Key Overview

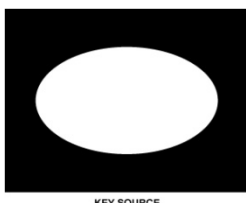

Luma Keying with the SE-3000 allows you to use an image, ideally black and white, to combine two images. The black element of the key image will be replaced by the full colour background image, and the white element will be replaced by the full colour key fill image. So the example sources shown on the left should produce the keyed output below.



=



Luma Key Quick Set Up

For this example we will be supplying the SE-3000 with a HD-SDI background feed on **input 10**. We will select the **STILL** button on the **Aux Bus row** and this will be used for Luma keying a static white shape over the video from input 10. We have already assigned a still with a black/dark background and white or light coloured text to the **STILL1** buffer – see **Loading an existing still from memory** on page 28.

Step 1: Choose the Keyer channel that you want to use. For our example we will press the **Key 2** button in the **Aux Bus Delegates** button group.

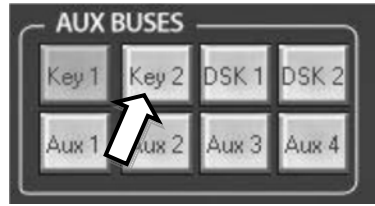

Step 2: Choose the type of Keyer you want to use. In our example we will press the **Luma** button in the Keyer Controls button group.



Step 3: Select the foreground video source to be keyed. In our example we want to use the **STILL 1** source to overlay some text. So we would press **STILL** on the **Aux Bus Row** so it is **backlit Green**. We have also chosen button 10 on the Program row as our background video.



Step 4: Turn the keying effect on. Press the **On** button so it is backlit green. In our example you will now see the selected source button **STILL**, on the **Aux Bus Row** change so it is now **backlit Red**.



Step 5: Make some adjustments to the Luma key. Press the **Keyer** button in the **Menus** button group and look at the Touch Screen Menu Panel.

The options along the bottom of the Touch Screen will now allow you to **calibrate** for a white or black key using the **F1~F3 Function Dials** or the **Touch Screen**.

The following section will explain the effects of **Lift**, **Gain**, **Opacity** and **Invert**.



Luma Key – Lift

This setting affects dark/black areas in the key image/source feed. The key image/source feed is chosen on the **Aux Bus Row** and should be backlit Red. **Reducing the value of Lift** will make dark areas of this image/source more transparent. The background source/image chosen on the Program Bus Row will be showing only through the transparent areas.

Luma Key – Gain

This setting affects light/white areas in the key image/source feed. The key image/source feed is chosen on the **Aux Bus Row** and should be backlit Red. **Increasing the value of Gain** will make light areas of this image/source more solid. The background source/image chosen on the Program Bus Row will be showing only through the transparent areas.

Luma Key – Opacity

This setting affects how transparent the overall foreground key image/source is. The key image/source feed is chosen on the **Aux Bus Row** and should be backlit Red. **Increasing the value of Opacity** will make the overall key image less transparent.

Luma Key – Invert

This setting **reverses the effect the current Luma Key settings**. So if you can currently see the background video through the dark areas of the key image/source feed, then switching Invert On would make the background video show through only the light/white areas instead.

LIN Button

The LIN or Linear button sets up the keyer so it uses the luminance signals of the selected Key Source.

SELF Button

The SELF button sets up the keyer so it uses the luminance signals of the Key Fill. As the luminance signals of the key fill are being used then the key source information is ignored.

TOP Button

The SE-3000 is able to show **Key1** over **Key2** or **Key2** over **Key1** if they are both **ON** or active. Use the Top button to decide which Keyer will have **Priority**. See **Priority Button** on page 47 also.

Saving the Luma Key set up

Once you are happy with the Luma Key set up remember to **save your current user setup** (see page 30). In this way having several Keying set ups saved to different user memory slots allows you to switch to a previous Luma Key set up quickly.

Mask Menu

The Mask Menu provides controls for the Key Mask function for each of the SE-3000's keys whether Chroma or Luma in function. When the user presses the Mask Menu button, **the Mask Menu for the currently selected Keyer is displayed.**

Example: Press the **MASK** button in the **Menus** button group of the SE-3000 Control Panel / Keyboard.

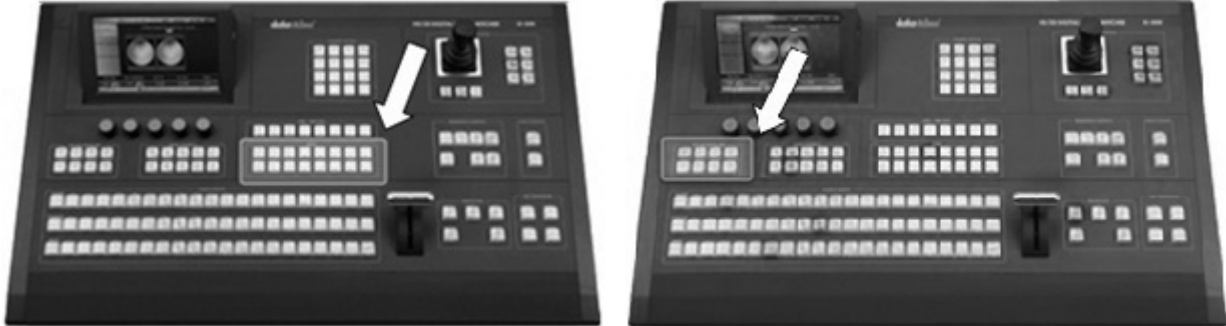

Now look at the **Aux Bus Delegate** group and make sure the correct Keyer is backlit Green.

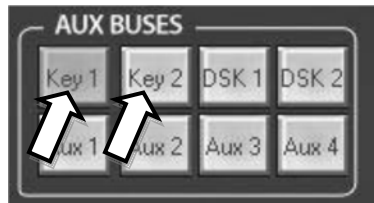

Once the correct keyer has been chosen the Mask function can then be switched on by pressing the **MASK** button in the **Keyer Controls** button group.



Now look at the Touch Screen Menu Panel. The Mask Menu options are shown at the bottom of the display.

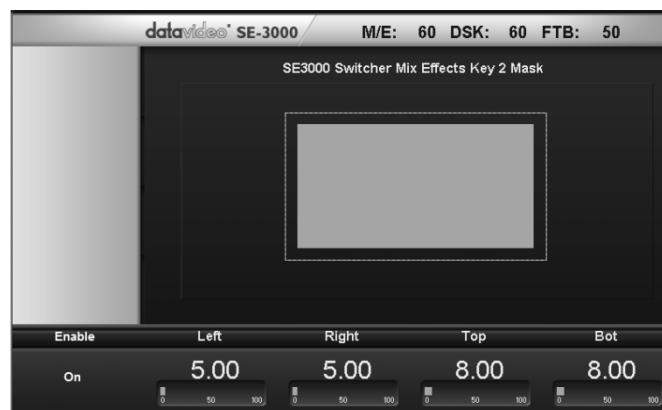

The **F2~F5 Function Dials** to allow the user to set the **Left, Right, Top & Bottom** edges of the keyer mask. These masked edges then become fully transparent during the keying process. This can be helpful if the blue or green screen backdrop does not occupy the whole foreground shot. It can also help if only a small area of the foreground image is being Luma keyed. Each value is based on a percentage of the screen width or height, 0% being no mask edge and 50% masking half of the screen area.

Keyer Matte

When **Matte** is selected in the **Keyer Controls** button group the current active Key is filled with a Matte colour rather than video. The **Keyer Matte** option allows selection of this Matte colour.

Once the correct keyer has been chosen and set up correctly the **Matte** function can then be switched on by pressing the **MATTE** button in the **Keyer Controls** button group.



Now look at the Touch Screen Menu Panel. The **Keyer Matte** options are shown at the bottom of the display.

Colour Palette



The Colour Palette allows selection of a colour for the Keyer Matte.

Tap on the Colour Palette and the crosshair + shows the currently selected colour which is also confirmed under the RGB values on the right.

The Hue adjustment moves the crosshair + around the colour palette in a clockwise or anti-clockwise direction. The **Hue** value/angle can be controlled by the **F1 Function dial**.

Certain colour hues can be found at certain angles on the colour palette. For instance, Red is 0 degrees (12 o'clock position), Green is approx 120 degrees (4 o'clock position) and Blue is approx 240 degrees (8 o'clock position). Secondary colours are Yellow at 60 degrees, Cyan at 180 degrees and Violet at 300 degrees.

The Sat or Saturation value moves the crosshair + from the centre of the colour palette to the outer edge. The **Sat** value can be controlled by the **F2 Function dial**. If the **Hue** angle is set at 180 then the **Sat** value determines how much Cyan is in the matte.

The Luma value relates to how bright or dark the selected colour or hue is. The **Luma** value can be controlled by the **F3 Function dial**.

Using Key 1 and Key 2

Once Key1 and Key2 are set up correctly, they can both be used separately within the same production or even placed over one another so they are both shown within the Preview/Program output.

Some preparation and thought has to go into using two keyers at the same time in a live production. The best way is to **keep the keys simple, decide which key should be on top** and **practice the effect that you want to create** a few days before the live event.



The SE-3000 has several buttons for deciding the on screen order of the Key1/Key2 as well as deciding how the key will enter, or exit, from the production. In the following example we will be using the **Transition Controls** and **Transitions** group of buttons on the Control Panel whilst looking at the Preview and Program monitors.

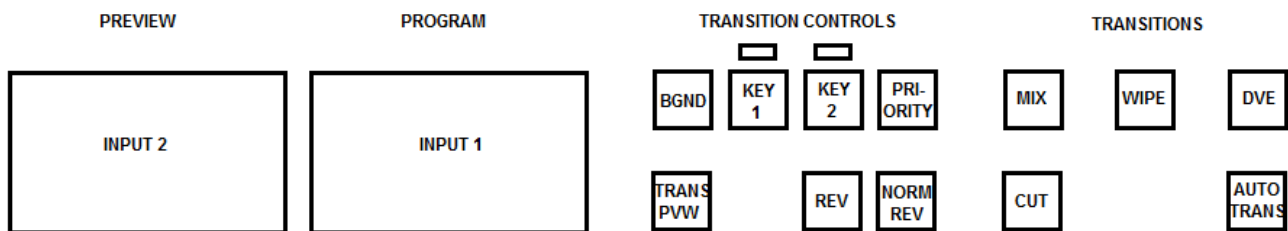

Transition Controls

BGND - Background

When on (back lit Green) this button includes the background image/video in any chosen transition from Preview to Program. When this button is toggled, or switched off, any Keyer transition chosen will not change the background Program image/video.

KEY1 / KEY2

Each KEY button has an LED above it. This LED can be Red or Green. The KEY button itself can be Off or On (back lit Green when On). To understand the relationship between the KEY button and the LED above try the following example with Key1 already set up as described under the previous Keying sections.

1. If the KEY1 button is Off and the LED above it is Red then KEY1 is not active in Program or Preview.
2. If the KEY1 button is On and the LED above it is Red then KEY1 is currently active in Preview Only.
3. If a CUT, MIX, WIPE or DVE transition is performed with the T-Bar or AUTO TRANS button then KEY1 will move to the Program output. Once the transition is complete the LED above KEY1 will change from Red to Green to confirm the key is currently active on the Program output.

4. If the T-Bar or AUTO TRANS button is used again then the KEY1 button will remain On but the LED above will change back from Green to Red. KEY1 is now removed from the Program output and is active only in the Preview output.
5. To remove KEY1 from the Preview output press the KEY1 button so it is Off and not back lit Green. The LED above KEY1 should be Red also. This confirms KEY1 is not active in Program or Preview and we are now back at point 1.

The Key2 button and the LED above it perform in exactly the same way as described for Key1.

Priority Button

When **Key1** and **Key2** are both active in Preview (or Program) they may overlap each other on screen. Using the **Priority Button** you can change the order of these keyers. The button acts in a toggle on/off way. So **Key1 over Key2** or **Key2 over Key1**.

NOTE: It is best to check and change the Priority of Key1 and Key2 when they are only active on the Preview monitor/output.

Previewing a selected transition

It is possible to see or test the effect of a chosen **MIX**, **WIPE** or **DVE** transition in the Preview Monitor before using it on the Program output.

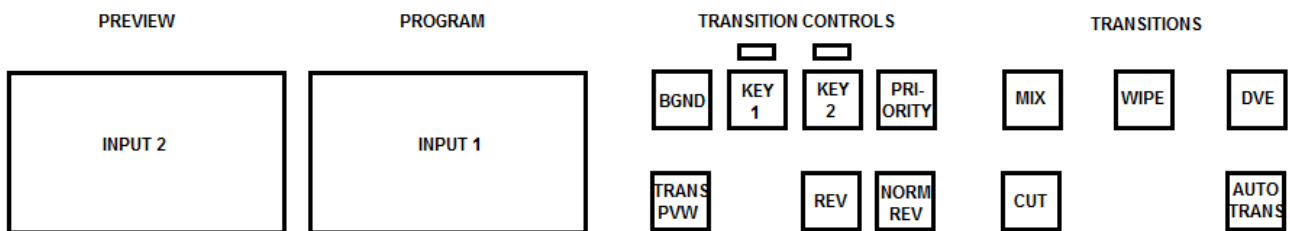

In order to do this look at the **Transition Controls** group of buttons on the Control Panel and below the **BGND** (Background) button is the **TRANS PVW** button. Once the **TRANS PVW** button is ON and backlit Green, select and use the transition that you want to test on the Preview monitor. You will also notice that the Preview Monitor switches to the currently selected Program source when the **TRANS PVW** button is turned on. Do not worry, the chosen Preset source has not changed. Press the **AUTO TRANS** button or move the **T-Bar** manually to preview the chosen transition.

NOTE: Remember to turn off the TRANS PVW button before attempting to use the chosen transition on the Program output.

REV and NORM / REV buttons

When the **REV** and **NORM / REV** buttons are **OFF** the selected WIPE or DVE transition will operate in its default direction only.

When the **REV** button is **ON** then the selected transition will operate in the reverse direction only.

When the **NORM / REV** button is **ON** the selected WIPE or DVE transition will automatically switch directions as each transition is completed. The **REV** button will switch on and off automatically to indicate the direction of the next transition.

DSK1 and DSK2 Quick Set Up

The DSK1 and DSK2 keyers can be used for Linear or Luma keying but cannot be set up for Chroma keying.

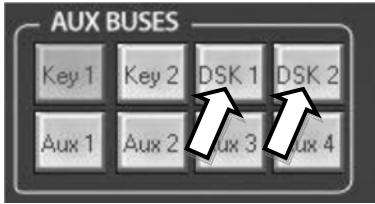

This is because only Key1 and Key2 are designed for Chroma key use.

For this example we will be supplying the SE-3000 with a HD-SDI background feed on **input 10**. We will select a **CG-350 overlay** input using **button 15** on the **Aux Bus** row

Step 1: Choose the Keyer channel that you want to use. For our example we will press the **DSK 1** button in the **Aux Bus Delegates** button group.

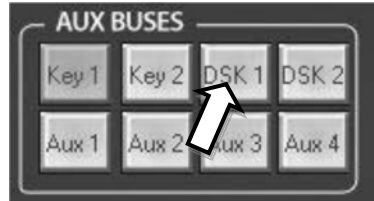

Step 2: Choose the type of Keyer you want to use. In our example we will press the **Luma** button in the Keyer Controls button group.



Step 3: Select the foreground video source to be keyed. In our example we want to use the **CG-350 input** source on 15 to overlay some text. So we would press **button 15** on the **Aux Bus Row** so it is **backlit Green**. We have also chosen button 10 on the Program row as this is our chosen background video.



Step 4: Turn the keying effect on. Press the **On** button so it is backlit green. In our example you will now see the selected source **button 15**, on the **Aux Bus Row** change so it is now **backlit Red**.



Step 5: Make some adjustments to the Luma key. Press the **Keyer** button in the **Menus** button group and look at the Touch Screen Menu Panel.

The options along the bottom of the Touch Screen will now allow you to **calibrate for a white or black key** using the **F1-F3 Function Dials** or the **Touch Screen**.

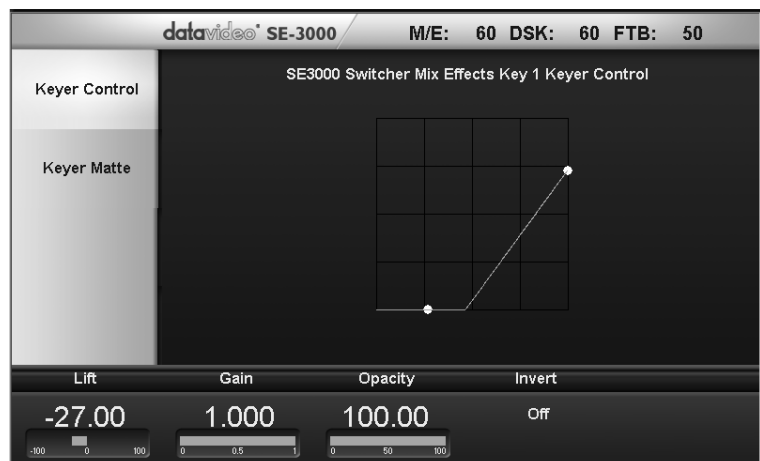

Saving the DSK1 DSK2 set up

Once you are happy with the DSK1 / DSK2 set up remember to **save your current user setup** (see page 30). In this way several Keying set ups can be saved to different user memory slots. This allows you to switch to a previous Keyer set up quickly.

SE-3000 Keying layers

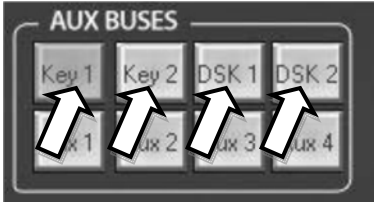

The SE-3000 has 4 dedicated keyers, **Key1**, **Key2**, **DSK1** and **DSK2**. All four keyers can be active at the same point in the production. However, these keyers have a layering order over any selected background source. The example diagram below gives you an idea of how these keyers are laid on top of each other.

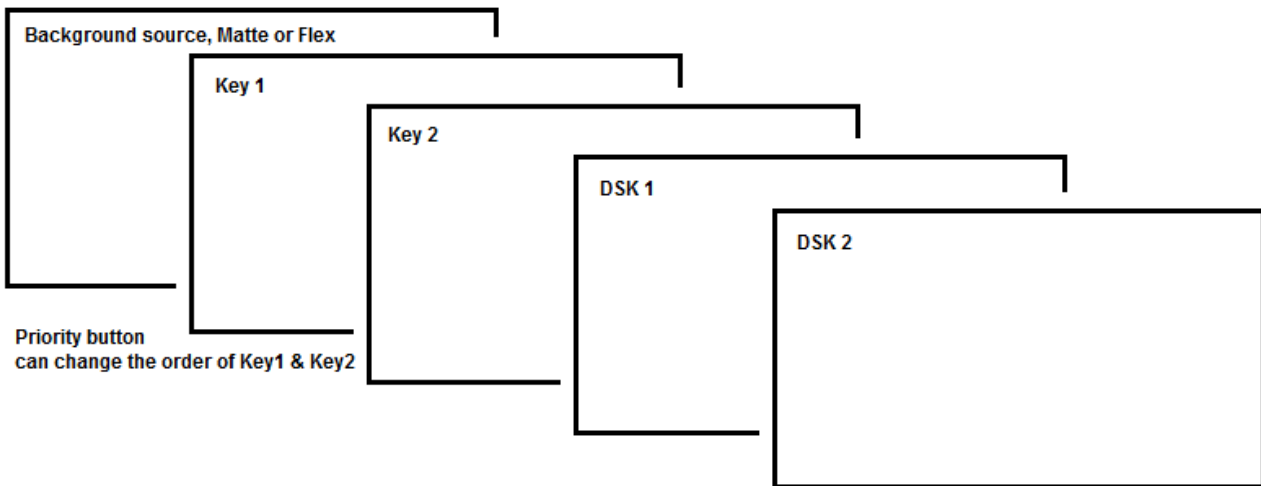

DSK Transitions

Each DSK button has an LED above it. This LED can be Red or Green. The DSK1 or DSK2 button itself can be Off or On (back lit Green when On). To understand the relationship between the DSK button and the LED above try the following example with DSK1 already set up as described on the previous page.

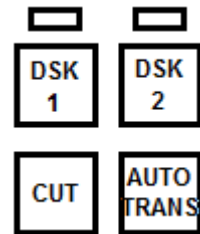

1. If the DSK1 button is Off and the LED above it is Red then DSK1 is not active in Program or Preview.
2. If the DSK1 button is On and the LED above it is Red then DSK1 is currently active in Preview Only.
3. If the CUT or AUTO TRANS button is pressed then DSK1 will move to the Program output. Once the transition is complete the LED above DSK1 will change from Red to Green to confirm the DSK is currently active on the Program output. **NOTE:** The T-Bar has no effect on DSK transitions.
4. If the CUT or AUTO TRANS button is used again then the DSK1 button will remain On but the LED above will change back from Green to Red. DSK1 is now removed from the Program output and is active only in the Preview output.
5. To remove DSK1 from the Preview output press the DSK1 button so it is Off and not back lit Green. The LED above KEY1 should be Red also. This confirms DSK1 is not active in Program or Preview and we are now back at point 1.

The DSK2 button and the LED above it perform in exactly the same way as described above.

Looping an External reference through the SE-3000



The SE-3000's built in TBCs can synchronise the input channels internally without the need for external genlock. However, you can choose to loop an external reference through the SE-3000 if you wish using the REF IN and REF LOOP (OUT) BNC connections provided on the rear of the Main unit.

Once the BNC connections have been made and the external reference is supplied follow the instructions below.

Press the **SETUP** button in the **Menus** button group on the Control Panel / Keyboard.



Now look at the Touch Screen Menu Panel.



Tap on **Genlock** in the Yellow menu list and the screen options below will be shown.



Tap on **Analog Ref** to select it as the **Genlock Source** and tap below **Enable** to show **On**.
Alternatively an Input from 1 to 8 could be chosen as the reference source instead.

Tally Output

The SE-3000 has a 37pin D-Sub Tally Output port. These ports provide bi-colour tally information to a number of other Datavideo products, such as the ITC-100 8 Channel Talkback system and TLM-434H LCD Monitor.

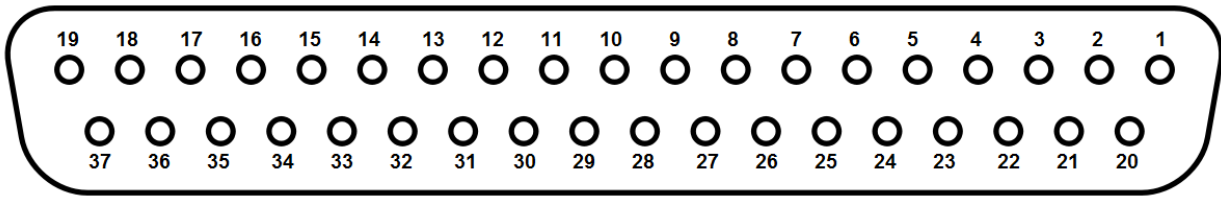

The output signals from the tally output pins are for lighting tally lamps, and these outputs are open collector outputs.

Input/channel	PGM / Red LED	Preset / Yellow LED
1	Pin 4	Pin 2
2	Pin 8	Pin 6
3	Pin 12	Pin 10
4	Pin 16	Pin 14
5	Pin 20	Pin 18
6	Pin 24	Pin 22
7	Pin 28	Pin 26
8	Pin 32	Pin 30
9	Pin 31	Pin 34
10	Pin 27	Pin 29
11	Pin 23	Pin 25
12	Pin 19	Pin 21
13	Pin 15	Pin 17
14	Pin 11	Pin 13
15	Pin 7	Pin 9
16	Pin 3	Pin 5

SE-3000 Pin 2 to 32 and 34 must satisfy the following conditions: Dielectric strength: Max. DC 24V
Current: Max. 50mA

SE-3000 Pin 1 is RESERVED and should be left unconnected. SE-3000 Pins 33, 35, 36 and 37 are Ground.

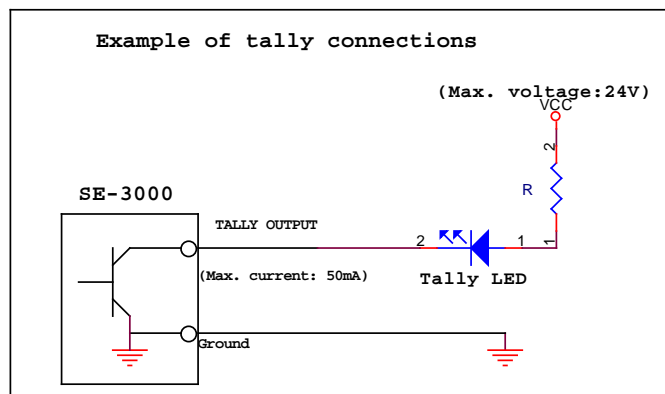

Tally connection to two ITC-100 units

It is possible using the diagram below to make a bespoke cable to connect the SE-3000 tally output to 2 x Datavideo ITC-100 units. All 5 connectors on the cabling will have male ends. Below table may also help when producing this cabling.

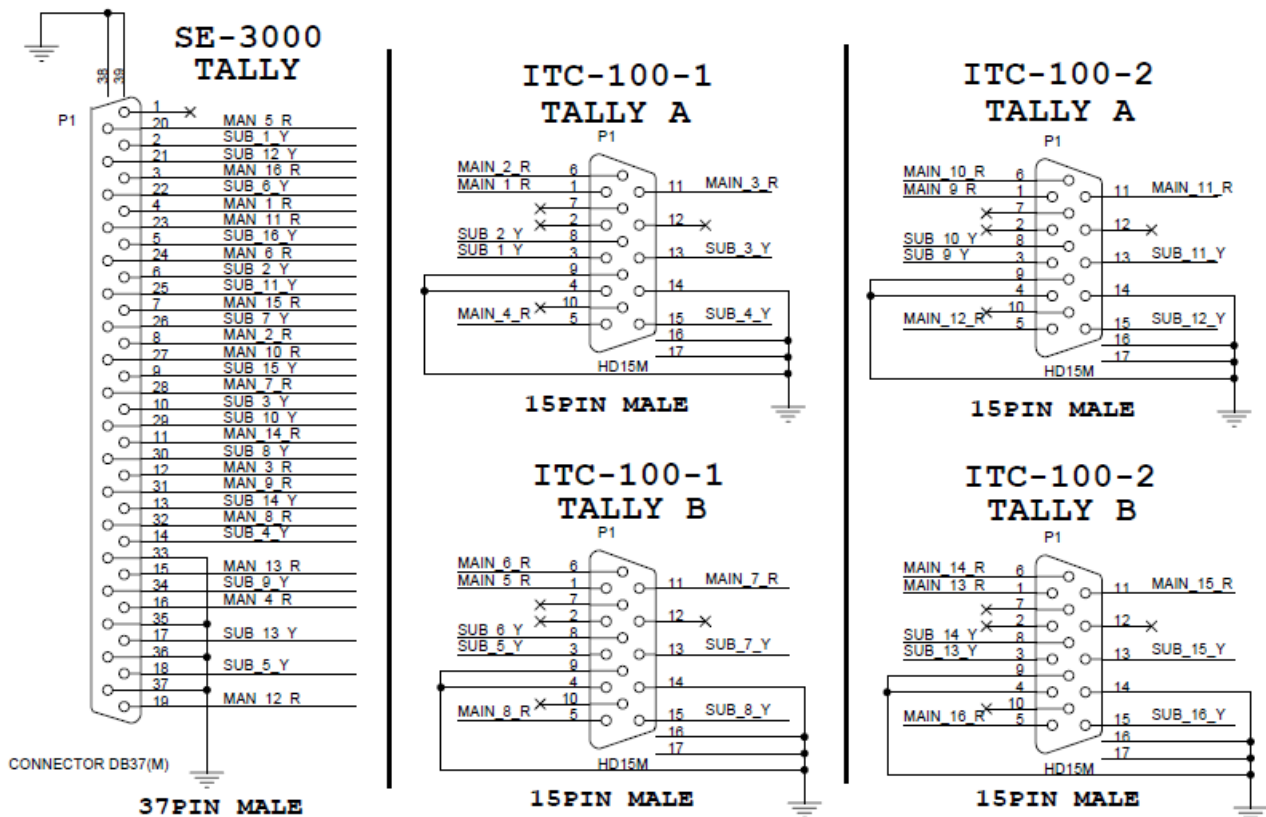

Input/channel	PGM / Red LED	ITC-100	Preset / Yellow LED	ITC-100
1	SE-3000 Pin 4	Unit 1 Tally A Pin 1	SE-3000 Pin 2	Unit 1 Tally A Pin 3
2	SE-3000 Pin 8	Unit 1 Tally A Pin 6	SE-3000 Pin 6	Unit 1 Tally A Pin 8
3	SE-3000 Pin 12	Unit 1 Tally A Pin 11	SE-3000 Pin 10	Unit 1 Tally A Pin 13
4	SE-3000 Pin 16	Unit 1 Tally A Pin 5	SE-3000 Pin 14	Unit 1 Tally A Pin 15
5	SE-3000 Pin 20	Unit 1 Tally B Pin 1	SE-3000 Pin 18	Unit 1 Tally B Pin 3
6	SE-3000 Pin 24	Unit 1 Tally B Pin 6	SE-3000 Pin 22	Unit 1 Tally B Pin 8
7	SE-3000 Pin 28	Unit 1 Tally B Pin 11	SE-3000 Pin 26	Unit 1 Tally B Pin 13
8	SE-3000 Pin 32	Unit 1 Tally B Pin 5	SE-3000 Pin 30	Unit 1 Tally B Pin 15
9	SE-3000 Pin 31	Unit 2 Tally A Pin 1	SE-3000 Pin 34	Unit 2 Tally A Pin 3
10	SE-3000 Pin 27	Unit 2 Tally A Pin 6	SE-3000 Pin 29	Unit 2 Tally A Pin 8
11	SE-3000 Pin 23	Unit 2 Tally A Pin 11	SE-3000 Pin 25	Unit 2 Tally A Pin 13
12	SE-3000 Pin 19	Unit 2 Tally A Pin 5	SE-3000 Pin 21	Unit 2 Tally A Pin 15
13	SE-3000 Pin 15	Unit 2 Tally B Pin 1	SE-3000 Pin 17	Unit 2 Tally B Pin 3
14	SE-3000 Pin 11	Unit 2 Tally B Pin 6	SE-3000 Pin 13	Unit 2 Tally B Pin 8
15	SE-3000 Pin 7	Unit 2 Tally B Pin 11	SE-3000 Pin 9	Unit 2 Tally B Pin 13
16	SE-3000 Pin 3	Unit 2 Tally B Pin 5	SE-3000 Pin 5	Unit 2 Tally B Pin 15

SE-3000 Pin 2 to 32 and 34 must satisfy the following conditions: Dielectric strength: Max. DC 24V
Current: Max. 50mA

SE-3000 Pin 1 is **RESERVED** and should be left unconnected. SE-3000 Pins 33, 35, 36 and 37 are Ground.

Features awaiting firmware development

Clip Menu

This menu has no function, as yet.

This feature is not active within the current version of firmware. Please check with your local Datavideo Office for firmware updates and a PDF copy of the latest manual.

Audio Menu

This menu has no function, as yet

This feature is not active within the current version of firmware. Please check with your local Datavideo Office for firmware updates and a PDF copy of the latest manual.

GPI connection

This connector has no function, as yet

This feature is not active within the current version of firmware. Please check with your local Datavideo Office for firmware updates and a PDF copy of the latest manual.

PIN1: GPI IN 1
PIN3: GPI IN 2
PIN5: GPI IN 3
PIN7: GPI IN 4
PIN9: GPI IN 5
PIN11: GPI IN 6
PIN13: GPI IN 7
PIN15: GPI IN 8

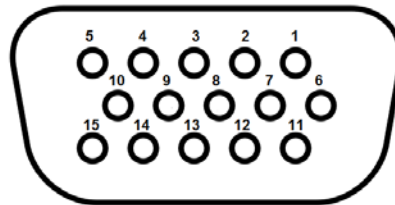

PIN2: GND
PIN4: GND
PIN6: GND
PIN8: GND
PIN10: GND
PIN12: GND

PIN14: GPI OUT

RS-232

This connector has no function, as yet

The SE-3000 features a 9pin D-Sub RS-232 port which is located on the rear panel of the Main unit.

This port is not active within the current version of firmware. Please check with your local Datavideo Office for firmware updates and a PDF copy of the control protocol.

<i>Pin</i>	<i>SE-3000 Signal</i>
1	
2	Transmit (TX-)
3	Receive (RX+)
4	
5	Ground
6	
7	
8	
9	

- Speed 9600bps
- 8 Bits
- 1 stop bit

RS-422 IN

This connector has no function, as yet

The SE-3000 features a 9pin D-Sub RS-422 IN port which is located on the rear panel of the Main unit.

This port is not active within the current version of firmware. Please check with your local Datavideo Office for firmware updates and a PDF copy of the control protocol.

<i>Pin</i>	<i>SE-3000 Signal</i>
1	Frame Ground
2	Transmit Z (TX-)
3	Receive A (RX+)
4	
5	
6	
7	Transmit Y (TX+)
8	Receive B (RX-)
9	Ground

- Speed 9600bps
- 8 Bits
- 1 stop bit

RS-422 OUT

This connector has no function, as yet

The SE-3000 features a 9pin D-Sub RS-422 OUT port which is located on the rear panel of the Main unit.

This port is not active within the current version of firmware. Please check with your local Datavideo Office for firmware updates and a PDF copy of the control protocol.

<i>Pin</i>	<i>SE-3000 Signal</i>
1	Frame Ground
2	Receive B (RX-)
3	Transmit Y (TX+)
4	
5	
6	
7	Receive A (RX+)
8	Transmit Z (TX-)
9	Ground

- Speed 9600bps
- 8 Bits
- 1 stop bit

Updating the SE-3000 firmware

From time to time Datavideo may release new firmware to either add new features or to fix reported bugs in the current SE-3000 firmware. Customers can update the SE-3000 firmware themselves if they wish or they can contact their local dealer or reseller for assistance should they prefer this method.

This page describes the firmware update process, if you have all the items required it should take **approximately 15 minutes total time to complete**.

NOTE: Once started ***the update process should not be interrupted in any way*** as this could result in a non-responsive unit.

As well as a working SE-3000 you will need:

- The latest zip file Firmware update for the SE-3000 from your local Datavideo office or dealer.
- The SE-3000 power supplies.
- An empty and anti-virus checked USB pen drive (128 MB minimum free space required).
- USB 2.0 male A to female A cable, to connect the USB pen drive to the SE-3000 Main unit.
- A Windows PC or Mac.

To update the SE-3000 firmware:

1. Unzip the Datavideo supplied file called **se3000_XXXXXX** to the PC/Mac Desktop so the unzipped folder and files are easy to locate. (XXXXXX = *the latest version number/date*)
2. Within this unzipped folder you are looking for four items. Two folders, one called **Se3000 Panel** and one called **Se3000 Processor**. The other two items will be Windows batch files, one called **se3000_CP_usb_startup** and one called **se3000_PU_usb_startup**.
3. **Copy these 4 items** (and their contents) into a **new folder** on the empty USB pen drive called **se3000**.
4. Switch **OFF** the SE-3000 in the normal way and remove the front ventilation plate on the Main unit using the four thumb screws.
5. Below the Main Unit's Power On button you will see two USB ports. Insert the USB pen drive into the **lower port**, gently. If the USB pen drive will not fit easily due to its case shape/size then use the optional USB 2.0 Male to Female cable to make connecting the USB pen drive easier.
6. Now power on the SE-3000 in the normal way. The Main Unit should see the USB pen drive and will auto update using the **se3000_PU_usb_startup** batch file. The unit will have completed the first part of the update process when the Multi-view images appear on the connected monitor(s).
7. Power down the SE-3000. Remove the USB pen drive (or any optional USB cabling) from the Main unit. Refit and secure the ventilation plate to the Main unit.
8. Now connect the USB pen drive to the USB port on the right hand side of the LCD touch screen.
9. Now power on the SE-3000 in the normal way. The Control Panel should see the USB pen drive and will auto update using the **se3000_CP_usb_startup** batch file. The unit will have completed the second part of update process when the Multi-view images appear on the monitors.
10. Press the **SET UP** button in the **MENUS** area of the Control Panel and check the Firmware Revisions displayed. That's it, done!

NOTE: Once started ***the update process should not be interrupted in any way*** as this could result in a non-responsive unit.

Checking Firmware Revisions

To check the software revision for the SE-3000, press the **SETUP** button within the **Menus** area of the Control Panel / Keyboard. Then look at the Touch Screen Menu Panel which should display the information required.



Please check with your local Datavideo office if you feel that your unit is not on the latest version of software.

Drawing Control Panel & Main Unit

All dimensions in mm.

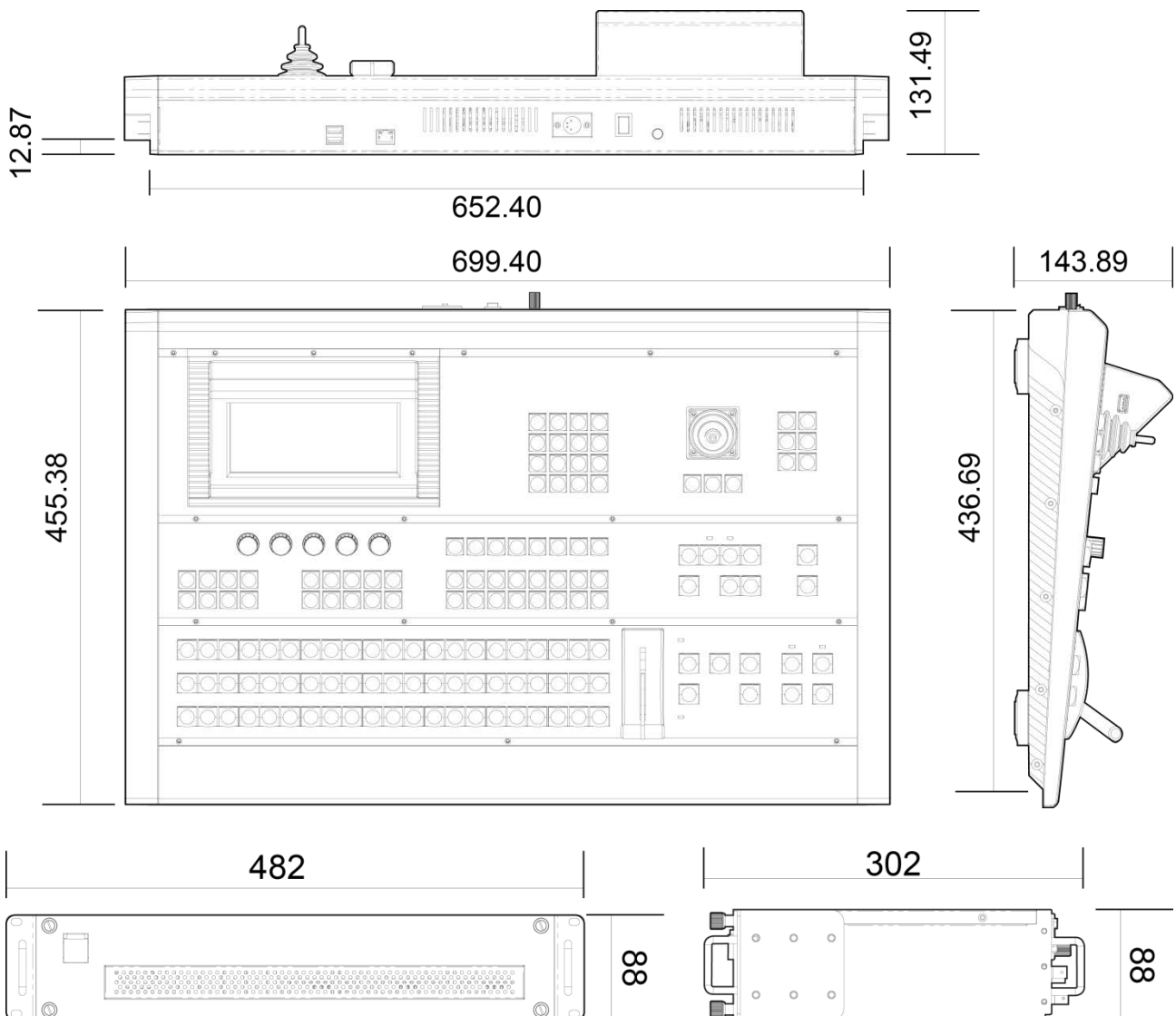

Specifications

Video format	SD (480/59.94i, 576/50i), HD (1080/59.94i, 1080/50i, 720/59.94p, 720/50p) Y:Cb:Cr, 4:2:2 10 bit RGB, 4:4:4 8 bit
SDI/HD-SDI Specifications	
Standard	SMPTE 259M-C (270 Mbps, 525/625 component video)
High Definition	SMPTE 292M (1.485, 1.485/1.001 Gbps)
Connector	BNC (IEC169-8)
Impedance	75 ohms
Return Loss	HD >15dB(5 MHz to 750 MHz), >10dB(750 MHz to 1.5 GHz) SD >15dB(5 MHz to 270 MHz)
Equalization	265 m Belden 8281 cable at 270 Mbps; 135 m (typical) of Belden 1694A at 1.485 Gbps
Operating temp.	0 °C to +40 °C
Humidity	10% to 90% (non condensing)
Power	Main Unit 12V 10A Control Panel 12V 3A
Dimensions	Main Unit 482(W) x 88(H) x 302(D) mm Control Panel 699.4 (W) x 143.89(H) x 436.6(D) mm
Weight	Main Unit 9KG Control Panel 10KG Combined (Nett) 19KG Packaged (Gross) 25KG

Specifications in this document are subject to change without notice due to planned improvements.

Service and Support

It is our goal to make your products ownership a satisfying experience. Our supporting staff is available to assist you in setting up and operating your system. Please refer to our web site www.datavideo-tek.com for answers to common questions, support requests or contact your local office below.

Datavideo Global Website: www.datavideo-tek.com

Datavideo Corporation

Tel: +1 562 696 2324	Fax: +1 562-698-6930	E-Mail: contactus@datavideo.us
----------------------	----------------------	--

Datavideo Technologies Europe BV

Tel: +31-30-261-96-56	Fax: +31-30 261-96-57	E-Mail: service@datavideo.nl
-----------------------	-----------------------	--

Datavideo UK Limited

Tel: +44 1457 851 000	Fax: +44 1457 850 964	E-Mail: sales@datavideo.co.uk
-----------------------	-----------------------	--

Datavideo Technologies Co., Ltd

Tel: +886 2 8227 2888	Fax: +886-2-8227-2777	E-mail: service@datavideo.com.tw
-----------------------	-----------------------	--

Datavideo Technologies China Co., Ltd

Tel: +86 21-5603 6599	Fax:+86 21-5603 6770	E-mail: service@datavideo.cn
-----------------------	----------------------	--

Datavideo Technologies (S) PTE Ltd

Tel: +65-6749 6866	Fax: +65-6749 3266	E-mail: sales@datavideo.sg
--------------------	--------------------	--

Datavideo HK Ltd

Tel: +852 2833 1981	Fax: +852-2833-9916	E-mail: info@datavideo.com.hk
---------------------	---------------------	--

All the trademarks are the properties of their respective owners.

Datavideo Technologies Co., Ltd. All rights reserved 2012.